



Excelencia en Distribución Ferretera

DISTRIBUIDORA ARTICULOS FERRETEROS

VENTA POR MAYOR.

CUERDA TRENZADA POLIPROPILENO



CODIGO	MEDIDA	COLOR	ML	VALOR
380201001	8 MM - 200 MT 6 KG	BLANCO/ROJO	\$167	
380201007	6 MM - 400 MT 6 KG	BLANCO/VERDE/AZUL	\$99	
3800201005	4 MM (CRR 600 MT) 4.2 KG	BLANCO	\$68	
3800201002	10 MM X 200 MT 9 KG	BLANCO/VERDE/ROJO	\$229	
3800201003	12 MM X 200 MT 12 KG	BLANCO/NEGRO/NARANJO	\$299	

OFERTA INCORPORACION

- ❖ 2 CARRETES 2% DESCUENTO
- ❖ 3 CARRETES 4% DESCUENTO
- ❖ SOBRE 4 CARRETES 6% DESCUENTO

IMPORTACION ACCON

MANGUERA PISCINA CON CONECTOR



CODIGO	MEDIDA	VALOR
2300606005	10 MT	
2300606006	15 MT	





CEPILLO ACERO INX CURVO

CODIGO	MEDIDA	VALOR
2400805005	25 CMS	



CEPILLO PLASTICO CURVO

CODIGO	MEDIDA	VALOR
2400805004	45 CMS	



MANGO TELESCOPIO LIMPIA PISCINAS

CODIGO	MEDIDA	VALOR
2400805007	1,8 -3,6 MTS	



RECOJE HOJAS PLANO

CODIGO	MEDIDA	VALOR
2400805002	46 X 31 CMS	



RECOJE HOJAS MALLA TIPO BOLSA

CODIGO	MEDIDA	VALOR
2400805003	44 X 19	



IMAGEN REFERENCIAL

TEST MIDE PH Y CLORO EN TIRAS 2 EN 1

CODIGO	VALOR
2400805009	

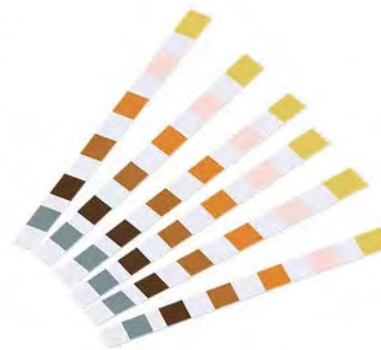

KIT MANTENCION PISCINAS

CONTIENE:

- **CEPILLO PLASTICO MEDIDA 45 CMS**
- **TEST DE CLORO Y PH**
- **TERMOMETRO**
- **CARRO LIMPIA FONDO**
- **RECOJE HOJAS PLANO**

COD: 2400805001

DOSIFICADOR CLORO PISCINA ADELANTO TEMPORADA



AGOTADO

CODIGO	MEDIDA	VALOR
2400805013	12 CMS	
2400805008	23 CMS	



MANGUERAS



BICOLOR

CODIGO	MEDIDA	VALOR
2300302001	ESTRIADA 1/2	
2300302002	EXTRA 1/2	
2300302003	EXTRA 3/4	
2300302004	EXTRA 1	



MANGUERA VERDE CRISTAL-GALACTICA

CODIGO	MEDIDA	VALOR
2300301006	1/2 X 100 MT	
2300301001	1/2 X 100 MT	
2300301002	3/4 X MT	
2300301005	1 X 100 MT	

ESTÁNDAR

EXTRA

EXTRA

EXTRA



MANGUERA MALLAFLEX

CODIGO	MEDIDA	VALOR
2300303001	1/2 X 100 MT	
2300303003	1" 50 MT	
2300303002	3/4 X 100 MT	

**OFERTA DICIEMBRE
10% DE DESCUENTO**

BICOLOR CON ACCESORIOS



CODIGO	MEDIDA	VALOR
2300304001	15 MT	



MALLAFLEX

CODIGO	MEDIDA	VALOR
2300304003	15 MT SIN ACC	
2300304002	15 MT CON ACC	

PLANA AZUL

CODIGO	MEDIDA	VALOR
2300606001	1 1/2"100 MT	
2300606002	2 X 100 MT	

**ENTREGA MAXIMA
10 DIAS HABLES**



MANGUERA NIVEL

CODIGO	MEDIDA	VALOR
2300101001	100 ML	



MANGUERA AMARILLA

CODIGO	MEDIDA	VALOR
2300201001	100 ML	



MANGUERA ESPIRALADA P/ MOTOBOMBA

- 1 x 1 RLL (50 ml)
- 2 x 1 RLL (50 ml)
- 3 x 1 RLL (25 ml)

MALLAS



CODIGO	COLOR	MEDIDA	VALOR
2200101003	VERDE	2,1 Mts x 100Mt	
2200101001	NEGRA	2,1 Mts x 100Mt	
2200101007	AZUL	2,1 Mts x 100Mt	
2200101011	AZUL/ BLANCO	2,1 Mts x 100Mt	



CODIGO	COLOR	MEDIDA	VALOR
2200101002	NEGRA 80%	4,2 Mts x 100Mt	
2200101004	VERDE 80%	4,2 Mts x 100Mt	
2200101006	VERDE/BLANCO	4,2 Mts x 100Mt	
2200101013	AZUL/BLANCO	4,2 Mts x 100Mt	
2200101010	BLANCO	4,2 Mts x 100Mt	
2200103006	BEIGE 90%	4,2 Mts x 100Mt	
2200101008	AZUL	4,2 Mts x 100Mt	

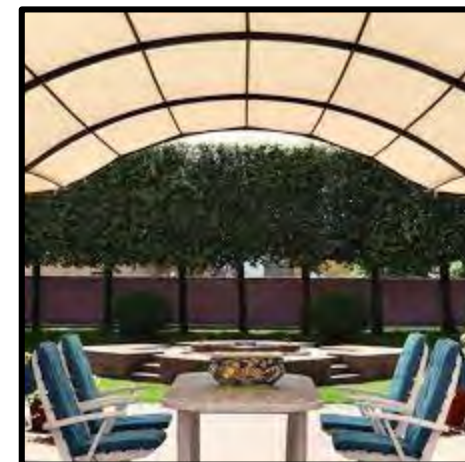

BROCHE CLIP MALLA SOMBRA



COD: 2200104001

BOLSA 50 UND



AGOTADO

STOCK LIMITADO

SACO ESCOMBROS REFORZADO 60 x 80Cm



COD. 2200201003

CANTIDAD	VALOR
100 unidades	
500 unidades	

PRECIO ESPECIAL SOBRE 2000 UNIDADES



CODIGO	TIPO	MEDIDA	VALOR
2200301001	FAENA	1,2 Mts x 50Mt	

MANGAS



MANGA NEGRA

CODIGO	MEDIDA	VALOR
2250102001	1 a 4 MT X 50 MT	



MANGA TRANSPARENTE VIRGEN

CODIGO	MEDIDA	VALOR
2250101001	1 a 4 MT X 50 MT	



MANGA INVERNADERO

**ENTREGA MÁX. 10 DÍAS
HÁBILES.**

CODIGO	MEDIDA	VALOR
2250103001	2 a 6 MT X 50 MT	PEDIDO



MANGA RIEGO (0.30 mic)

15 CM X 292 MT .

30 CM X 146 MT .

OTRAS MEDIDAS A PEDIDO

10 CM SON 10 KG

20 CM X 219 MT

25 cm X 219 MT

60 CM X 73 MT

TODAS EN ROLLO DE 25 KG.

ORILLADORA 122 C

Desbrozadora de tubo curvo, ideal para usuarios particulares y áreas de pequeño tamaño. 122C destaca por su arranque sencillo Smart Start®, su transmisión flexible y su tubo de 1380 mm.



0,6 kW

Potencia

43 cm

Anchura de corte

4,4 kg

Peso, sem
combustível ou
equipamento de
corte



DESBROZADORA 321R

- INCLUYE:
- CUCHILLO
- CARRETE

CODIGO	VALOR
2400102008	

DESBROZADORA 236R

- INCLUYE:
- CUCHILLO
- CARRETE NYLON

CODIGO	VALOR
2400102002	

DESBROZADORA 226R

CODIGO	VALOR
2400102010	



Dimensiones

- Alto: 95 cm
- Ancho: 27 cm
- Largo: 27 cm
- Peso: 1,7 kg

INCLUYE 1 CARRETE DE NYLON

PRODUCTO TEMPORADA

ORILLADORA TRAMONTINA 1500 WATT



- Diámetro de corte de 28cm.
- Su motor posee una velocidad de 11000rpm.
- Sistema de corte: hilo
- Pesa 2.62kg.
- Dimensiones: 30cm de ancho, 91cm de alto, 89cm de largo.
- Mantiene el césped prolijo llegando a todos los bordes necesarios.
- No incluye batería



COD: 2400102012

CARRETE ORILLADORA T35



IMAGEN REFERENCIAL

CODIGO	VALOR
2400102004 M10	
2400102007 M12	

MAQUINAS DISPONIBLES PARA LOS SIGUIENTES MODELOS:

M10

123L, 123LD, 128LDx, 133R, 223L, 223R, 224L, 226R, 232L, 232R, 233RJ
 323L, 323LD, 323R, 323R-II, 323RJ, 324LDx, 324Lx, 324Rx, 325LDx, 325Lx
 325RDx, 325RJx, 325Rx, 326L, 326LDx, 326LS, 326Lx, 326RJx, 326Rx
 327LDx, 327LS, 327RDx, 327RJx, 327Rx, 523L, 525L, 525LDx, 525LS
 525LST, 525Rx, 533RS

M12

135R, 143R, 143R-II, 153R, 235FR, 235R, 235R-II, 236R, 241R, 243RJ
 253RB, 333R, 333RJ, 335FR, 335LS, 335Lx, 335RJx, 335Rx, 336FR
 336FRD, 535LS, 535RJ, 535Rx, 535Rxt, 543RS, 543RBDx, 553RBx



JOCKEY LEGIONARIO

CODIGO	MEDIDA	VALOR
2800102001	TALLA UNICA	



BLOQUEADOR SOLAR BANANA BOAT FACTOR

CJ 10 UND

CODIGO	MEDIDA	VALOR
2800601002	1 LT	



IMAGEN SOLO REFERENCIAL

BUZO DESECHABLE POLIPROPILENO

CODIGO	MEDIDA	VALOR
2800401006	XL	
2800401007	XXL	
2800401009	XXXL	

CAJA 50 Unidades

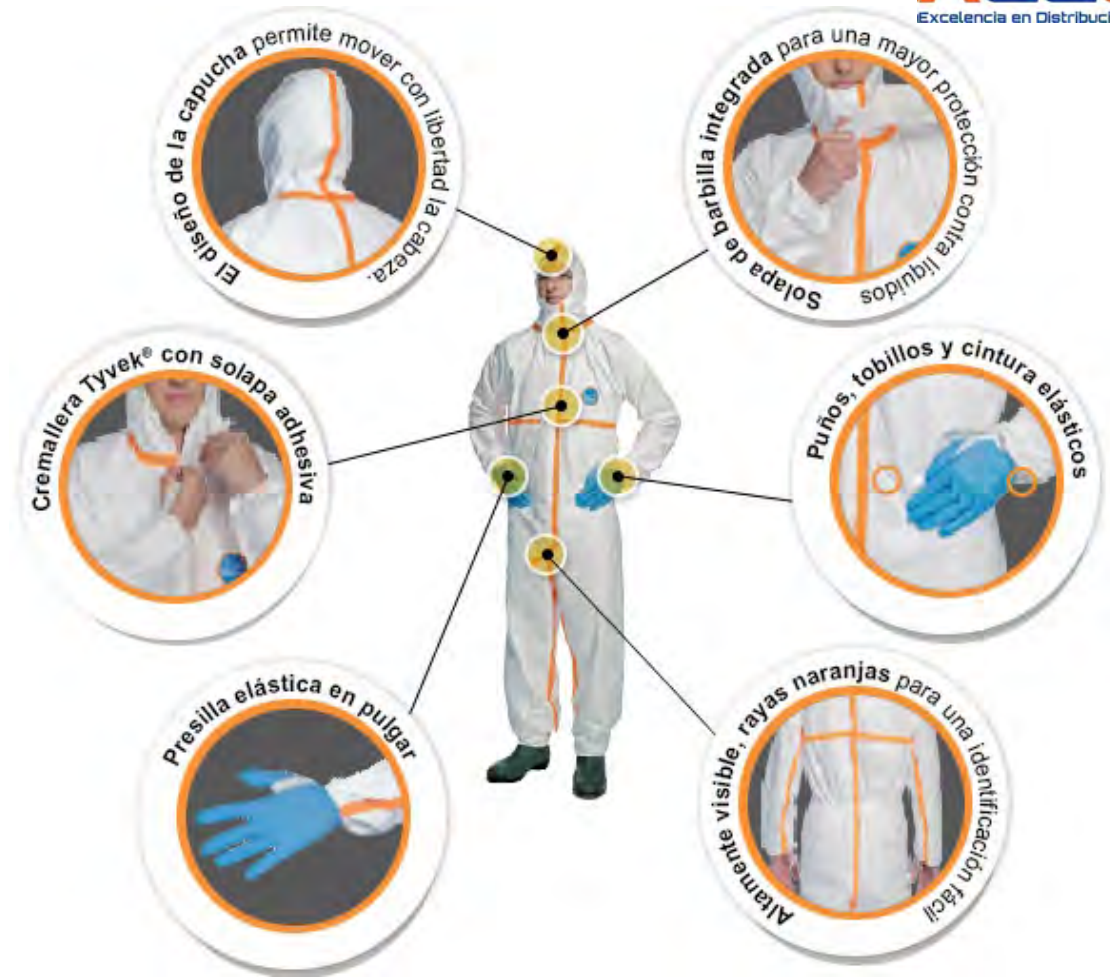
**POR COMPRA SUPERIORES A \$250 MIL EN PRODUCTOS ACCON
VALOR OFERTA POR CADA 10 UNIDADES**

NO APLICA OFERTA EN TALLA L

ACCESORIOS DE PINTURA



 **ATLAS**
BROCHAS Y RODILLOS

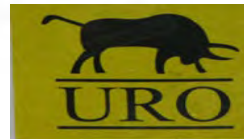

NEXXO[®]

BROCHAS MANGO PLASTICO MOD.396 BOLSA DE 12 UND.

CODIGO	MEDIDA	VALOR
2100101001	1/2	
2100101002	3/4	
2100101003	1"	
2100101005	2"	
2100101004	1 1/2"	
2100101006	2 1/2"	
2100101007	3"	
2100101008	4"	

BROCHAS URO MANGO MADERA

CODIGO	MEDIDA	VALOR	CANT. PACK
2100202029	1"		12
2100202030	1,5"		12
2100202032	2,5"		12
2100202033	3"		12
2100202034	4"		6

BROCHAS NEXXO MANGO PLASTICO

CODIGO	MEDIDA	VALOR
2100101023	1.0"	24 UND
210101025	2.0"	24 UND
2100101024	1 ½"	24 UND
2100101026	2 ½"	12 UND
2100202027	3.0"	12 UND
210101028	4,0"	12 UND



RODILLO GRAVITY

Rodillo especialmente diseñado para aplicar pastas y pinturas con granito fino, epóxicos, resinas y adhesivos. Para uso en superficies lisas.

Aplicador de revestimientos.



18 CM

COD. 2100207001



RODILLO SINTETICO PELO LARGO

CODIGO	MEDIDA	VALOR
5071	7	
5121	12	
5181	18	
5241	23	

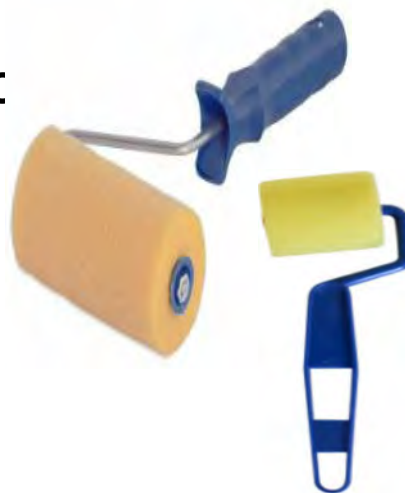

RODILLO ESPONJA (SOLO AGUA)

CODIGO	MEDIDA	VALOR
345	4,5	
307	7	
309	9	
312	12	
318	18	



RODILLO SINTETICO PELO CORTO

CODIGO	MEDIDA	VALOR
5072	7	
5122	12	
5182	18	
5242	23	



RODILLO ESPUMA (SOLVENTES)

CODIGO	MEDIDA	VALOR
3205	5	
3207	7	
3209	11	
3215	15	
3218	18	
3223	23	

FOTOS REFERENCIALES



RODILLO ECONOMICO PATAGON

CODIGO	MEDIDA	VALOR
P118	18 MM	
P51818	18 CM	

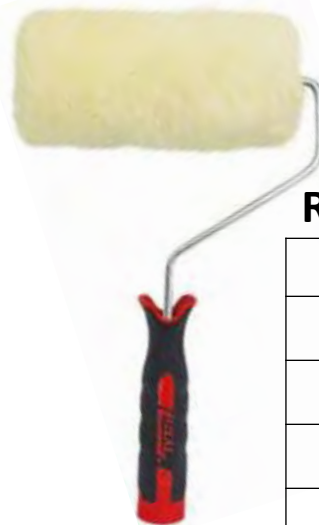

RODILLO CHIPORRO NATURAL

CODIGO	MEDIDA	VALOR
105	5 CMS	
112	12 CMS	
118	18 CMS	
124	50 MM	
123	9 A 23 CMS	



RODILLO ANTIGOTA

CODIGO	MEDIDA	VALOR
5124	12 CMS	
5184	18 CMS	
5244	23 CMS	



RODILLO SINT. TEXTURADOR

CODIGO	MEDIDA	VALOR
3181	18 CMS	

RODILLO ANTIGOTEEO NEXXO



CODIGO	MEDIDA	VALOR
2100204012	18 CMS	



RODILLO CHIPORRO NEXXO MIXTO

CODIGO	MEDIDA	VALOR
2100204013	18 CMS	



BANDEJA GRANDE

CODIGO	MEDIDA	VALOR
2100302001	34X30	



HUAIPÉ BLANCO

CODIGO	MEDIDA	VALOR
2100601002	250 GR	
2100601003	500 GR	
2100601004	1000 GR	



SET ESPATULAS DENTADAS PLASTICAS

CODIGO	MEDIDA	VALOR
2000102003	2-3-4-6	



SET ESPATULAS PLASTICAS LISA

CODIGO	MEDIDA	VALOR
2000102001	2-3-4-6	



**LLANA DENTADA ACERO
MANGO PLASTICO 8MM TX**

CODIGO	MEDIDA	VALOR
2000103002	CAJA 12 UND	



LLANA LISA MANGO PLASTICO

CODIGO	MEDIDA	VALOR
2000103001	CAJA 12 UND	



**PLANA BOTADORA MANGO
MADERA**

CODIGO	MEDIDA	VALOR
2000103004	CAJA 12 UND	

SPRAY ESMALTE ACRILICO

passol



VERDE BRILLANTE
COD. 2600102004

SECADO RAPIDO



Aluminio
2600101006



Amarillo
2600101005



Azul
2600101008



Celeste
2600101019



Azul Oscuro
2600101027



Beige
2600101028



BLANCO BRILLANTE
2600101002



BLANCO MATE
2600101004



DORADO
2600101012



GRAFITO
2600101035



NARANJO
2600101029



NEGRO BRILLANTE
2600101001



NEGRO MATE
2600101003



ROSA
2600101025



VERDE
2600101007



VERDE OSCURO
2600101026



MARRÓN
2600101024



ROJO
2600101009

CAJAS 6 UNIDADES



METALIZADO



Cobre

2600101030



Cromo

2600101011



Oro

2600101031



Dorado

2600101034



FLUORESCENTE



Naranja

2600101017



Verde

2600101015

ANTI-CORROSIVO



Negro

2600101014



Verde

2600101023



Gris

2600101022

ALTA TEMPERATURA



Aluminio

2600101033



Negro

2600101013



Brillante

2600101021



Mate

2600101020



Roble

2600101037



Nogal

2600101039



Alerce

2600101038



Caoba

2600101036



MATE - BRILLANTE

ROBLE – NOGAL – ALERCE – CAOBA

LUBRICANTE MULTIUSO 40



CODIGO	MEDIDA	VALOR
2400201009	400 ML -12 Unidades x caja	

LIMPIADOR DE CONTACTO



CODIGO	MEDIDA	VALOR
2400201014	400 ML -12 Unidades x caja	

ADHESIVOS CONTACTO



CODIGO	MEDIDA	VALOR
2901201001	60 CC CAJA 24 UND	
2901201002	120 CC CAJA DE 48 UND	
2901201003	240 CC CAJA DE 24 UND	

ADHESIVOS PVC



CODIGO	MEDIDA		VALOR
2901202002	20 cc	36 un. X caja	
2901202001	60CC	24 un. X caja	
2901202003	250CC	24 un. X caja	

ADHESIVOS



ADHESIVO INSTANTANEO

CODIGO	MEDIDA	VALOR
2900801001	2 GR CAJA DE 24 UND	

ACERO LIQUIDO GRIS BLÍSTER

CODIGO	MEDIDA	VALOR
2901204002	56 GR CAJA DE 12 UND	



**COLA FRIA FRASCO DOSIFICADOR
CAJA X 24 UND**

CODIGO	MEDIDA	VALOR
2901206002	500 GR	

**FRASCO DOSIFICADOR
CAJA X 12 UND**

CODIGO	MEDIDA	VALOR
2901206004	1 kg	

DOY PACK

CAJA 6 UND

CODIGO	MEDIDA	VALOR
2901206001	500 gr	

DOY -PAK

CAJA 12 UND

CODIGO	MEDIDA	VALOR
2901206003	1 kg	



PISTOLA BLISTER
CAJA X 12 UND

CODIGO	MEDIDA	VALOR
2901203001	0,7 CMS	
26901203002	1, 2 CMS	



REPUESTO SILICONA

CODIGO	MEDIDA	VALOR
2901205001	REX HOT MELT BARRA 0,7cm x 10cm, BOLSA 10un x 48	
2901205004	REX HOT MELT BARRA 1,2cm x 30cm, BOLSA 4 un x 12	
2901205002	REX HOT MELT BARRA 0,7cm x 30cm, BOLSA 20un x 24	
2901205003	REX HOT MELT BARRA 1,2cm x 30cm, BOLSA 20un x 12	



AGOREX-60

CODIGO	MEDIDA	VALOR
2901001001	1/32 GL CAJA 48 UND	
2901001002	1/16 GL CAJA 24 UND	
2901001003	1 LT CAJA DE 12 UND	



AGOREX NO MAS CLAVOS

CODIGO	MEDIDA	VALOR
2901001011	100 CC CAJA DE 12 UND	
2901001012	200 CC CAJA DE 12 UND	



AGOREX-60

CODIGO	MEDIDA	VALOR
2901001005	20 CC CAJA DE 48 UND	
2901001006	120 CC CAJA DE 48 UND	



AGOREX-TRANSPARENTE ESTUCHE

CODIGO	MEDIDA	VALOR
2901001007	20 CC CAJA DE 48 UND	

REGULADORES



REGULADOR GAS BERCATTI

CODIGO	VALOR
1700201001	



REGULADOR CON FLEXIBLE ATG

CODIGO	MEDIDA	VALOR
1700201004	15 K	



REGULADOR SIN FLEXIBLE CEMCO

CODIGO	MEDIDA	VALOR
1700201002	15 - 11 - 5 KG	





REGULADOR CON FLEXIBLE DE COBRE CEMCO 45K

CODIGO	MEDIDA	VALOR
1700201003	45 K	



REGULADOR BERCATTI 45K INDICADOR DE CARGA

CODIGO	MEDIDA	VALOR
1700201009	45 K	



LLAVE PASO GAS ½



CODIGO	MEDIDA	VALOR
1800801001	1/2	



FLEXIBLE GAS COFLEX.

CODIGO	MEDIDA	VALOR
1800401005	7/8 HI x 1/2 HI 100 CM	



FLEXIBLE GAS HI-HI

CODIGO	MEDIDA	VALOR
1800401010	½ x 3/8 x 0,60 MT	
1800401002	½ x ½ x 0,60 MT	
1800401001	½ x ½ x 1.0 MT	
1800401003	3/8 x ½ x 1.0 MT	

GAS BUTANO



GAS BUTANO C/VALVULA CERTIFICADO

Venta solo por Caja de 36 und.

CODIGO	MEDIDA	VALOR
1700101002	190 GR	



GAS BUTANO C/VALVULA CERTIFICADO

CODIGO	MEDIDA	VALOR
1700101003	230 GR CJ 24 UND	



GAS BUTANO C/VV

CODIGO	MEDIDA	VALOR
1700101001	227 GR	

NOTA: MARCA SEGÚN DISPONIBILIDAD.

Soplete a gas Portatil Bercatti T190

DESCRIPCIÓN

Soplete a gas **Portatil- Bercatti**, liviano, portátil y seguro. Útil para gasfitería y trabajos domésticos. Empuñadura ergonómica de PVC con mayor adherencia.

Utiliza cartucho de **gas de 190gr**
Ideal para retirar pinturas, limpiar superficies, soldadura de tuberías, repostería





**COCINILLA C/ MALETA P/CAMPING
GAS 227 GR**

CODIGO	MEDIDA	VALOR
1700401013	345X280X115 MM	



**SOPLETE YANES PROF 2001 K
P/ GAS 227**

CODIGO	MEDIDA	VALOR
1700301008	CAJA 6 UND	



**SOPLETE PLASTICO PROF. MOD 160
S/CHISPERO**

CODIGO	VALOR
1700301001	



**SOPLETE METALICO PROF. MOD 200
C/CHISPERO
CAJA 6 UND**

CODIGO	VALOR
1700301003	



**SOPLETE METALICO PROF. MOD 400
C/CHISPERO**

CODIGO	VALOR
1700301012	



SOLDADURA ESTAÑO 50%

CODIGO	MEDIDA	VALOR
3000101001	1/2" KG	



SOLDADURA. ESTAÑO AL 50%

CODIGO	MEDIDA	VALOR
3000101002	5 KG	



SOLDADURA ESTAÑO 1 MT

CODIGO	MEDIDA	VALOR
3000101008	SIN PASTA 20 UND	
3000101003	CON PASTA 10 UND	



SOLDADURA ELECTRONICA

CODIGO	MEDIDA	VALOR
3000101004	1/2 KG	



ESTAÑO BARRA 50%

CODIGO	MEDIDA	VALOR
3000101009	50% 2 UND CAJA DE 25 UND	



SOLDADURA PLATA

CAJA CON 5 DISPLAY

CODIGO	MEDIDA	VALOR
3100101013	5% DISPLAY 2 UND	
3000101005	15% DISPLAY 2 UND	



CODIGO	MEDIDA	VALOR
3000201001	50 GR CAJA DE 18 UND	
3000201002	100 GR CAJA DE 12 UND	
3000201003	250 GRS CAJA DE 12 UND	
3000201004	500 GRS CAJA DE 6 UND	



FUNDENTE SOLDURA PLATA

CODIGO	MEDIDA	VALOR
3000101006	50 GR CAJA 12 UND	

FITTING

	<p>CODO SO-SO 3/8 (BOLSA 20) CODO SO-SO 1/2 (BOLSA 20) CODO SO-SO 3/4 (BOLSA 10) CODO SO-SO 1 -11/4- 11/2 PEDIDO</p>		<p>CODO HI- HI 1/2 CODO HI-HI 3/4 (BOLSA 20)</p>
	<p>CODO SO-HI 1/2 (BOLSA 20) CODO SO-HI 3/4</p>		<p>CODO HI- HE 1/2 CODO HI- HE 3/4 (BOLSA 20)</p>
	<p>CODO SO-HE 1/2 (BOLSA 20) CODO SO-HE 3/8 CODO SO-HE 3/4 PEDIDO</p>		<p>COPLA SO-SO 3/8 (BOLSA 30) COPLA SO-SO 1/2 (BOLSA 30) COPLA SO-SO 3/4 (BOLSA 30) COPLA PASADA SO-SO 1/2</p>
	<p>CODO REDUC. 3/8 X 1/2 CODO REDUC. 3/4 X 1/2 (Bolsa 20 UN.)</p>		<p>COPLA REDUC 3/8 X 1/2 (BOLSA 20) COPLA REDUC 1/2 x 3/4 (BOLSA 20) COPLA REDUC 3/4 X 1 (BOLSA 10)</p>

FITTING

	<p>TEE SO-SO 3/8 TEE SO-SO 1/2 TEE SO-SO 3/4 TEE SO-SO 1</p> <p>TEE SO-SO TEE SO-SO</p> <p>BOLSA 15 UNIDADES</p>		<p>TAPA GORRO SO X 3/8 TAPA GORRO SO X 1/2 TAPA GORRO SO X 3/4</p> <p>BOLSA 50 UNIDADES</p>
	<p>TERMINAL SO-HE 1/2 TERMINAL SO-HE 3/4 * TERMINAL SO-HE 3/8 TERMINAL SO – HE 3/8 X 1/2</p> <p>BOLSA 20 UNIDADES</p>		<p>TAPA TORN. HE X 1/2 TAPA TORN. HE X 3/4 (BOLSA 50)</p> <p>TAPA GORRO HI X1/2 (BOLSA 50)</p> <p>TAPA GORRO HI X 3/4 (BOLSA 50)</p>
	<p>TERMINAL SO-HI 1/2 TERMINAL SO-HI 3/4 *</p> <p>BOLSA 20 UNIDADES</p>		<p>TEE SO-SO-HI 1/2</p>
	<p>UNION AMERICANA SO-SO 1/2 (BOLSA 10)</p> <p>UNION AMERICANA SO-SO 3/4 * (BOLSA 20)</p>		<p>NIPLE HE HE 3/4 x 1/2 LATON</p> <p>NIPLE HE HE 1/2 X 3/8</p>

	<p>NIPLE HI-HE 1/2 COD: 1800302007</p> <p>NIPLE TUERCA HI-HE 3/4 LATON COD: 1800302005</p>		<p>TEE UNION MANG. BRONCE 3/8 \$ COD: 1800305002</p> <p>Bolsas 20 UN</p>
	<p>CACHIMBA RECTO</p> <p>HI 3/8 (H.IZQ) COD: 1800304003</p> <p>HI 1/2 COD: 1800304001</p>		<p>CONECTOR LLAVE JARDIN</p> <p>1/2 x 1/2 COD: 1800305003</p> <p>3/4 x 3/4 COD: 1800305005</p> <p>3/4 x 1/2 COD: 1800305004 Bolsas 20 UN</p>
	<p>CACHIMBA RECTO HE 1/2</p> <p>Bolsas 20 UN COD: 1800304002</p>		<p>CODO CACHIMBA HI 1/2 Bolsas 20 UN COD: 1800303001</p>
	<p>COPLA UNION MANGUERA 3/8 Bolsas 20 UN COD: 1800305001</p>		<p>HILO C/TUERCA 1/2 Bolsas 20 UN COD: 1800302003</p>

FITTING

	<p>FILTRO Y HI-HI ½</p> <p>Bolsa 6 UN.</p> <p>COD. 1801001011</p>
	<p>NIPLE HILO HI-HI ½</p> <p>BOLSA DE 20 UN.</p> <p>COD. 1800302008</p>
	<p>EXCENTRICA 47-52 MM</p> <p>\$ 890</p> <p>COD: 1800207001</p>

GRAFICA	FITTING DE PPR	BOLSA	\$ NETO				
	CODO 90° F-F 20MM	30 UN.			COPLA F-F 20 MM	30 UN.	
	CODO 90° F-F 25 MM	30 UN.			COPLA F-F 25 MM	30 UN.	
	CODO F-HE 20 MM X ½"	30 UN.			TEE F-F-F 20 MM	30 UN.	
	CODO F-HE 25 MM X ½"	30 UN.			TEE F-F-F 25 MM	30 UN.	
	CODO F-HI 20 MM X ½"	30 UN.			TERMINAL F-HE 20 MM X ½"	30 UN.	
	CODO F-HI 25 MM X ½"	30 UN.			TERMINAL F-HE 25 MM X ½"	30 UN.	
	TAPAGORRO 20 MM	30 UN.			TERMINAL F-HI 20MM X ½"	30 UN.	
	TAPAGORRO 25 MM	30 UN.			TERMINAL F-HI 25 MM X ½"	30 UN.	
	REDUCCIÓN 20 X 25 MM	30 UN.					



PPR VALVULA DE BOLA

BOLSA 6 UND

CODIGO	MEDIDA	VALOR
1820102006	20 MM	
1820102007	25 MM	



PVC HIBRAUL VALVULA

BOLA PEGAR CONNOR

BOLSA 6 UND

CODIGO	MEDIDA	VALOR
1810101001	20 MM	
1810101002	25 MM	
1810101003	32 MM	



PPR LLAVE DE PASO MANILLA ROJA

BOLSA 6 UND

CODIGO	MEDIDA	VALOR
1820102004	20 MM	
1820102005	25 MM	



PPR LLAVE DE PASO CROM. M/ TRIANGULAR CUELLO CORTO

BOLSA 6 UN

CODIGO	MEDIDA	VALOR
1820102001	20 MM	
1820102003	25 MM	

CODIGO	MEDIDA	VALOR
1910101001	20 A 63 MM	





FIJACIONES ESTANQUE

Perno Caupolicán (bolsa 12 UN)

CODIGO	VALOR
1800102008	



SELLO CERA ANTIFUGA WC

\$860 x caja

CJM 60

CODIGO	VALOR
1800102005	



COLLARIN GOMA WC

C/PESTAÑA

(CJM 120 / CJ 6)

CODIGO	VALOR
1800102007	



TEFLON DOMESTICO

CODIGO 1/2	VALOR	PAQ.	MASTER
180050100		10 UND.	250 UND.

TEFLON AMARIILLO

CODIGO 1/2	VALOR	PAQ.	MASTER
1800502001		10 UND.	250 UND.



CODIGO 3/4	VALOR	PAQ.	MASTER
1800501002		10 UND.	250 UND.

CODIGO 3/4	VALOR	PAQ.	MASTER
1800502002		10 UND.	250 UND.



TEFLON JUMBO (50 MT)

CODIGO 3/4	VALOR	PAQ.	MASTER
1800501004		10 UND.	250 UND.

Blanco. Densidad 0.3 gr/cm³; Espesor 0.100 mm; Largo 50 mts; Ancho: 3/4" . En Bobina con carcaza Plásticos.

TEFLON MAESTRO (15 MT)

CODIGO 3/4	VALOR	PAQ.	MASTER
1800501003		10 UND.	250 UND.

Densidad 0.4 gr/cm³; Espesor 0.200 mm; Largo 15 mts ; Ancho: 3/4" . Mayor Resistencia. En Bobina con carcaza Plásticos. Diam.Ext=76 mm.



ACCESORIOS DE BAÑO

FIJACIONES WC a PISO
(BOLSA 12 UN)

CODIGO	VALOR
1800102001	



BOTONERA DUAL FLUSH

CODIGO	VALOR
1800104004	



KIT LLAVE ANGULAR C/FLEXIBLE INOX
(CJM 60 / UMC6)

CODIGO	MEDIDA	VALOR
1850204001	35 cms	



DESAGÚE LAVATORIO SIN COLA

CODIGO	MEDIDA	VALOR
1800103006	1/2	



LLAVE ANGULAR DE MEDIA HE-HE
(BOLSA 6 UN)

CODIGO	VALOR
1800701008	



DESAGUE LAVATORIO S/REBALSE S/COLA

CODIGO	MEDIDA	VALOR
1800103007	1 1/4"	





**KIT INSTALACION WC ANCLAJE
WC**

SELLO ANTIFUGA

FLEXIBLE INOX 35

LLAVE ANGULAR

CODIGO	VALOR
1800102012	



**VALVULA DESCARGA
C/FLAPPER**

CODIGO	VALOR
1800102006	



**FLAPPER PARA WC C/
CADENA METALICA**

CODIGO	VALOR
1800102004	



**KIT CARGA DESCARGA
CON FIJACION -ESTANQUE**

CODIGO	VALOR
1800102011	

ACCESORIOS DE BAÑO



**MANILLA
ESTANQUE WC**

CODIGO	VALOR
1800104003	



**VALVULA DESCARGA
DUAL FLUSH**

CODIGO	VALOR
1800102009	



**VALVULA CARGA
ESTANQUE WC**

C/FLOTADOR
CONECT 15/16

CODIGO	VALOR
1800102003	



**VALVULA DESCARGA
DUAL FLUSH**

CODIGO	VALOR
1800102010	



**VALVULA CARGA
TIPO FM**

CONECTOR 15/16

CODIGO	VALOR
1800102002	



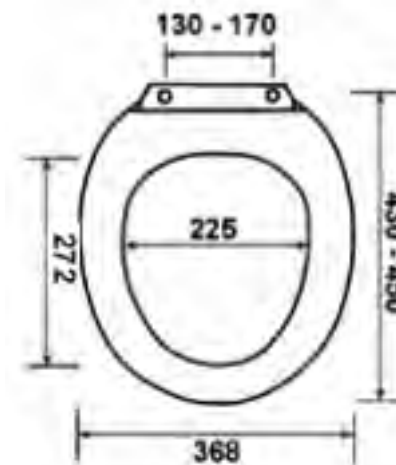
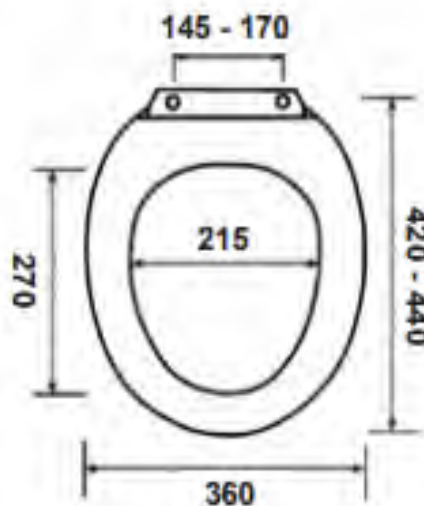

ASIENTO WC COLOMBA



ASIENTO WC MODERN SLOW



ASIENTO WC ECONOMICO

CODIGO	VALOR
1800104001	

CODIGO	VALOR
1800104002	

CODIGO	VALOR
1800104005	

ACCESORIOS DE BAÑO



PERCHERO COLOMBA BAÑO

CODIGO	VALOR
1850602022	



TOALLERO ARO COLOMBA

CODIGO	VALOR
1850602020	



PORTA ROLLO PAPEL HIGENICO COLOMBA

CODIGO	VALOR
1850602021	



TOALLERO BARRA COLOMBA

CODIGO	MEDIDA	VALOR
1850602023	60 CMS	



TOALLERO BARRA ACERO INOX.

CODIGO	MEDIDA	VALOR
1850602024	60 CMS	



REJILLA DE BRONCE 10 x 10

CODIGO	MEDIDA	VALOR
3600101003	10 X 10	

ACCESORIOS DUCHA



BARRA SEGURIDAD ACERO INOXIDABLE

CODIGO	MEDIDA	VALOR
1850801001	25MM X 40 CMS	
1850801002	32MM X 60 CMS	



BASE MANGO DUCHA CON VENTOSA

CODIGO	VALOR
1830203001	



BASE MANGO DUCHA SWETT

CODIGO	VALOR
1800101004	

DESAGÜE



SIFON PLÁSTICO

CODIGO	MEDIDA	VALOR
1800103010	1 1/4	



SIFON LAVAPLATO DOBLE

C/Des + REVALSE

CODIGO	MEDIDA	VALOR
1800103011	1 1/4 X 1 1/2	



SIFON LAVAPLATO

C/DESAGUE + REVALSE

CODIGO	MEDIDA	VALOR
1800103004	1 1/4 X 1 1/2	



MANGUERA LAVADORA

CODIGO	VALOR
1800402014 ENTRADA	
1800103002 SALIDA	



GRIFERIA MODELO COLOMBA



**MONOMANDO
LAVATORIO**

CODIGO	VALOR
1850203001	



MONOMANDO DUCHA

CODIGO	VALOR
1850202001	



**MONOMANDO
LAVAPLATO**

CODIGO	VALOR
1850201001	



**MONOMANDO TINA-
DUCHA**

CODIGO	VALOR
1850202002	



MONOMANDO LAVATORIO

CODIGO	MEDIDA	VALOR
1850203003	CAJA 12 UND	



MONOMANDO DUCHA

CODIGO	MEDIDA	VALOR
1850202007	CAJA 12 UND	



MONOMANDO LAVAPLATO

CODIGO	MEDIDA	VALOR
1850201003	CAJA 12 UND	



MONOMANDO TINA-DUCHA

CODIGO	MEDIDA	VALOR
1850202006	CAJA 12 UND	

GRIFERIA MODELO VANDER



**COMBINACION LAVAPLATO
VANDER en V**

CODIGO	VALOR
1850301003	



**COMBINACION
TINA-DUCHA VANDER**

CODIGO	VALOR
1850202008	



**COMBINACION DUCHA
VANDER VOLK**

CODIGO	VALOR
1850202005	



**COMBINACION
LAVAPLATO VANDER
CUERPO FUNDIDO**

CODIGO	VALOR
1850301002	

GRIFERIA



LAVACOPA TAUMM

CODIGO	VALOR
1850102001	



COMBINACION LAVAPLATO

ANTONELLA CUELLO CORTO
CAJA 16 UN

CODIGO	VALOR
1850301001	



COMBINACION LAVAPLATO

ANTONELLA CUELLO ALTO
X CAJA \$ 6.550 C/U

CODIGO	VALOR
1850301007	



**COMBINACION LAVAPLATO EN V
TOLEDO**

CODIGO	VALOR
1850301011	

COMBINACION DUCHA ECO SIN GARANTIA



COD: 1850202004



LLAVE LAVATORIO

ECO—CHICA (CJ.48)

CODIGO	VALOR
1850101001	



LLAVE LAVATORIO

ECO—MEDIANA

(CJ 2 Un)

CODIGO	VALOR
1850101002	

MONOMANDO LAVATORIO MODERN

- Alto: 16,5 cm
- Largo: 13,5 cm
- Alto hasta la salida de agua: 10 cm.
- Material: Acero Inoxidable
- Cierre cerámico 40 mm
- Flexibles de Acero Inoxidable 35 cm.
- Kit de Fijación Acero Inoxidable y metal cromado.



COD: 1850203002



MONOMANDO CUELLO FLEXIBLE



GRIFERIA MONOMANDO CUELLO FLEXIBLE BASE METALICA NO IMANTADA COLORES DISPONIBLES



1850301009 NEGRA
1850301010 ROJA
1850301008 VERDE

ACCESORIOS

KIT DUCHA SWERTT



(CJM36)

Mango Flexible Soporte

CODIGO	VALOR
1800101001	



MANGO FREIBURG

CODIGO	VALOR
1800101007	

KIT DUCHA FREIBURT



(CJM36)

Mango de 3 Lluvias

Flexible

Soporte

En Display

CODIGO	VALOR
1800101006	



MANGO SWERTT

CODIGO	VALOR
1800101002	

KIT BIDET ARABE MANGO CROMADO



Mango: ABS cromado pulsador on-off (puede quedar en "on") ; Flexible 1 mt EPDM y Acero Inoxidable; colgador cónico ABS cromado; Diverter de latón cromado HI-HE-HE 7/8"x7/8"x1/2"

COD: 1850501003



FLEXIBLE DUCHA TAUMM

CODIGO	MEDIDA	VALOR
1800101003	1, 60 MTS	



FLEXIBLE DUCHA

ELASTICO EXTENSIBLE DUSCHY

CODIGO	MEDIDA	VALOR
1830202001	1,5 A 2,0 MTS	



**JUEGO EKO CROMO
MANGO+FLEX + SOPORTE**

CODIGO	VALOR
1830201001	



**JUEGO EUROSPRAY
CROMO DUSCHY**

CODIGO	VALOR
1830201003	



BARRA DUCHA RIO CROMADO

Mango de ducha 3 funciones
Soporte de ducha ajustable
Flexible metálico de 1.5 mts
Jabonera ajustable

CODIGO	MEDIDA	VALOR
1830204003	FLEXIBLE 1, 5 MTS	



BARRA CORTINA EXPANDIBLE

CODIGO	MEDIDAS	VALOR
1830204002	0,75 A 1,25 CMS	
1830204001	0.75 A 1,25 CM	
1830204004	0,75 A 2,25 CMS	
1830204005	0.75 A 2.25 CMS	



Poliéster Mollusc



Sistema HOOKLESS de cuelgue fácil
Incluye bastilla con peso para evitar
Que la cortina se pegue al cuerpo
100% Poliéster
180x180cm

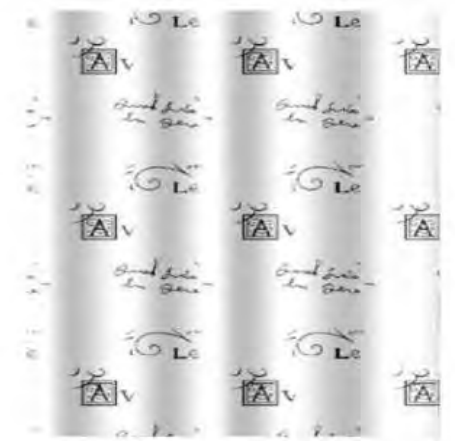

Poliéster script



Poliéster Cat Blue

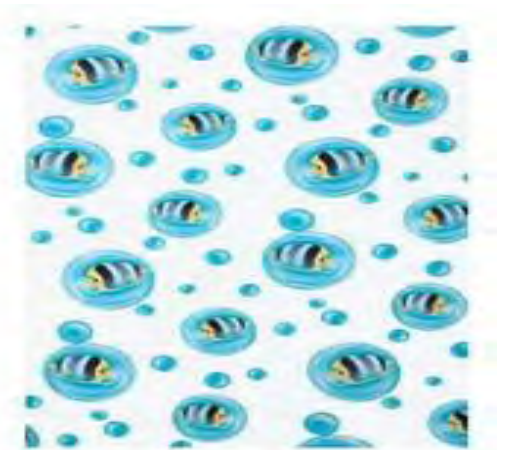

Poliéster Scuba

FLEXIBLES MALLA INOXIDABLE

FLEXIBLE HI-HI 1/2



CODIGO	MEDIDA	VALOR
1800402002	35 CM.	
1800402001	25 CM.	
1800402015	30 CM.	
1800402003	40 CM.	
1800402004	50 CM.	
1800402024	60 CM.	
1800402023	100 CM.	



FLEXIBLE M10 HI HE 1/2

CODIGO	MEDIDAS	VALOR
1800402013	35 CM	
1800402025	50 CM	



FLEXIBLE HI HI1/2X 15/16

Para Llave Angular Estanque WC

CODIGO	MEDIDAS	VALOR
1800402020	25 CM	
1800402019	30 CM	
1800402021	35 CM	

FLEXIBLE HI-HE 1/2



CODIGO	MEDIDAS	VALOR
1800402005	25 CM.	
1800402016	30 CM.	
1800402006	35 CM.	
1800402007	40 CM.	
1800402008	50 CM.	
1800402024	60 CM.	



FLEXIBLE P/CALEFONT

CODIGO	MEDIDA	VALOR
1800402017	25 CM HI HI	
1800402018	25 CM HI HE	
1800402026	35 CM HI HI	
1800402027	35 CM HI HE	



VALVULA BOLA HI-HI
BOLSA 6 UND

CODIGO	MEDIDA	VALOR
1800901001	1/2	
1800901002	3/4	
1800901003	1	
1800901004	1¼	



VALVULA FONDO - PIE
CON REJILLA INOXIDABLE
BOLSA 3 UND

CODIGO	MEDIDA	VALOR
1801001003	1	
1801001004	1 1/4	
1801001005	1 1/2	
1801001006	2 PEDIDO	



VALVULA RETENCION VERTICAL
BOLSA 3 UND

CODIGO	MEDIDA	VALOR
1801001007	1	
1801001008	1 1/4	
1801001009	1 1/2	
1801001010	2 PEDIDO	



LLAVE JARDIN HE-HE
BOLSA 6 UND

CODIGO	MEDIDA	VALOR
1800601006	1/2	
1800601007	3/4	



LLAVE DE PASO LATON
CJM 80 (bolsa 6 und)

CODIGO	MEDIDA	VALOR
1800701001	1/2	
1800701003	3/4	



LLAVE BOLA JARDIN 1/2 x 3/4 ECO BOLSA 10UN.

3/4 x 1
1 x 1¼



LLAVE DE PASO CUELLO ALTO

(BOLSA 6 UND)

CODIGO	MEDIDA	VALOR
1800701004	1/2	



LLAVE PASO CRUZ

(BOLSA 6 UND)

CODIGO	MEDIDA	VALOR
1800702004	1/2	



LLAVE CAMPANA

(BOLSA 6 UND)

CODIGO	MEDIDA	VALOR
1800702003	1/2 POMO A PEDIDO	X CONFIRMAR



LLAVE PASO TIPO EMOS SIN MANILLA

CODIGO	MEDIDA	VALOR
1800701005	3/4	

CALEFONT



CODIGO	MEDIDA	PRECIO
1860203001	5 LTS	
1860203002	7 LTS	
1860203003	10 LTS	

CODIGO	MEDIDA	PRECIO
1860101001	5 LTS	
1860101002	7 LTS	
1860101003	10 LTS	

CALEFONES IONIZADOS USAN PILAS

AISLANTES TÉRMICOS PARA CAÑERIAS



CODIGO	MEDIDA	VALOR
3500101001	1/2 - 5/8	

TUBO POLIPEX

CODIGO	MEDIDA	VALOR
3500101002	2 MTS Y GROSOR DE 3/4	

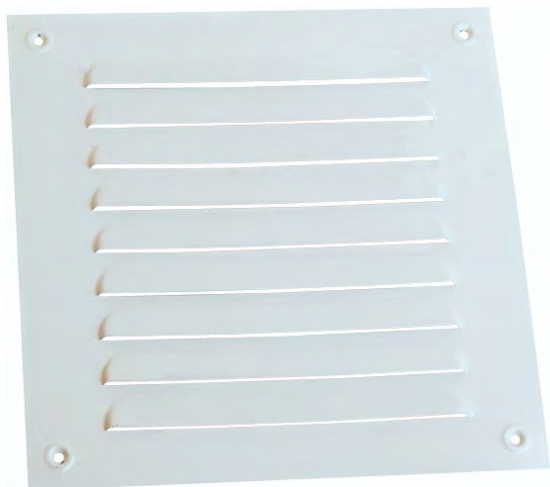

CELOSIA ACERO ESMALTADO BLANCO.

CODIGO	MEDIDA	VALOR
1801201001	20 X 20 CAJA 12 UND	

CELOSIA 30 X 30 ACERO ESMALTADO BLANCO

CODIGO	MEDIDA	VALOR
1801201002	30 X 30 CAJA 12 UND	

Compras de múltiplo de 4

CELOSIA 35 X 35 ACERO ESMALTADO BLANCO

CODIGO	MEDIDA	VALOR
1801201003	35 X 35 CAJA DE 12 UND	



EXTRACTOR DE AIRE

CODIGO	MEDIDA	VALOR
1500801001	15,7 X 15,7 CMS (4 ")	
1500801002	18 X 18X 1,8 (5 ")	



QUITA SARRO SOLIDO

CODIGO	MEDIDA	VALOR
1100101003	200 GR	

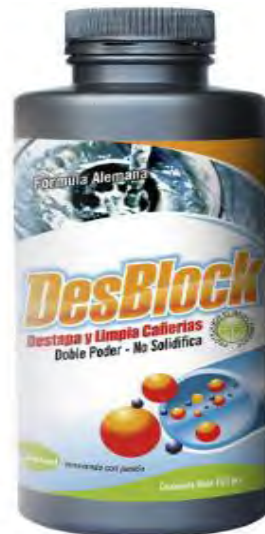

DESBLOCK

CODIGO	MEDIDA	VALOR
1100101005	700 GRS	



DESBLOCK POMO

CODIGO	MEDIDA	VALOR
1100101008	200 GRS	



DESTAP GEL ACTIVO 500cc

CODIGO	MEDIDA	VALOR
1100101002	500 CC	



MATA-RAIZ PASSOL

CODIGO	MEDIDA	VALOR
1100101007	500 GRS	



POLVO LIMPIADOR BIOLOGICO FOSAS Y POZOS SEPTICOS

Digestor enzimático para pozos sépticos y letrinas
Es una mezcla controlada de enzimas específicas.
Microorganismos seleccionados, no patógenos con diversas materias primas adecuadas para facilitar la labor digestiva de las enzimas y bacterias, permitiendo un adecuado control del PH.

CODIGO	MEDIDA	VALOR
1100101010	250 GR CAJA DE 5 UND	



GEL MATA RAICES DE SISTEMAS SEPTICOS

Actúa atacando y destruyendo sólo las raíces que han entrado a la red del alcantarillado o ductos de desagüe.
Es un método rápido y económico de prevenir el bloqueo de los ductos que es causado por las raíces de árboles y arbustos, sin matarlos. Manteniendo los tubos y ductos despejados.

CODIGO	MEDIDA	VALOR
1100101009	999 GRS CAJA DE 1 KG	

POMEL



CODIGO	MEDIDA	VALOR
3600202004	3/8 CAJA 70 UND	
3600202005	1/2 CAJA 40 UND	
3600202006	5/8 CAJA 30 UND	
3600202007	3/4 CAJA 10 UND	
3600202008	1 CAJA 10 UND	

GUIA PORTON CORREDERA



CODIGO	MEDIDA	VALOR
3600203009	SIMPLE	
3600203010	DOBLE	



RUEDA PORTON

C/ PASADOR PARA SOLDAR

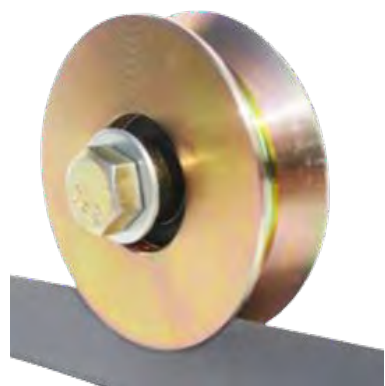

CODIGO	MEDIDA	VALOR
3600203001	(1.9 P) 50 MM 20 RUEDAS	
3600203002	(2.5 P) 64 MM 20 RUEDAS	
3600203003	(2.9 P) 75 MM 12 RUEDAS	
3600203004	(3.9 P) 100 MM 6 RUEDAS	



RUEDA PARA PORTON C/ PERNO

CODIGO	MEDIDA	VALOR
3600203005	50 MM 20 RUEDAS	
3600203006	64 MM 20 RUEDAS	
3600203007	75 MM 12 RUEDAS	
3600203008	100 MM 6 RUEDAS	
3600203014	70 MM	

RUEDA PORTON CON BASE

CODIGO	MEDIDA	VALOR
3600301001	48 MM	
3600301002	58 MM	
3600301003	68 MM	
3600301004	78 MM	



**CERRADURA SOBREPONER 2010
CHILENA - BLISTER**

CODIGO	VALOR
1400201010	



**CERRADURA SOBREPONER
CON CAJA METALICA LIOI**

CODIGO	VALOR
1400201012	



**CERRADURA BASH
SOBREP-PT CORREDERA
X CAJA 8 UND**

CODIGO	VALOR
1400201005	



**CERRADURA BASH SOBREP-PT
CON CAJA MOD. 1002
X CAJA 8 UND**

CODIGO	VALOR
1400201011	

CERRADURAS



CERRADURA LINEA NORDICA

ACCESO PRINCIPAL

CODIGO	VALOR
1400601001	

PRECIO X UNIDAD

CERRADURA YALE NEGRA

ACCESO

BAÑO—DORMITORIO

OFICINA—DORMITORIO

CODIGO	VALOR
1400102013	
1400102012	
1400102011	

CERRADURAS



CERRADURA CILINDRICA ESFERA POLI INOXIDABLE

CERRADURA CLASICA DORMITORIO B40 **BRONCE**

CODIGO	VALOR
1400601002	

CODIGO	DESCRIPCION	VALOR
1400502001	ACCESO	
1400502002	OFICINA/ DORM	
1400502003	BAÑO/DORM	
1400502004	SIMPLE PASO	

CERRADURAS



CERRADURA POMO

POLI

PASO LIBRE/ SIMPLE PASO
BAÑO - DORMITORIO
DORMITORIO – OFICINA
ACCESO



CERRADURA POMO

YALE PASO LIBRE/
SIMPLE PASO BAÑO -
DORMITORIO
DORMITORIO – OFICINA
ACCESO



CERRADURAS POMO

BASH

ACCESO PRINCIPAL
LOGIA (LLAVE/LLAVE)
6 UNI. X CAJA



TOPE CÓNICO

Bolsa de 20 Un

CODIGO	VALOR
3600401001	



ASSA ABLOY

SEGURIDAD



CANDADO POLI S.

CODIGO	MEDIDA	VALOR
1400104027	S-30 MM	
1400104028	S-40 MM	
1400104029	S-50 MM	
1400104030	S-60 MM	



CANDADO SEGURIDAD CON HOMBRO POLI X.

CODIGO	MEDIDA	VALOR
1400104034	50MM	
1400104035	60MM	



CANDADO POLI R.

CODIGO	MEDIDA	VALOR
1400104031	R-40MM	
1400104032	R-50MM	
1400104033	R-60MM	

SEGURIDAD



CANDADO SAFER

CODIGO	MEDIDA	VALOR
1400104008	25 MM	
1400104009	30 MM	
1400104007	40 MM	
1400104010	50 MM	
1400104011	60 MM	



CANDADO 98TI/90 MONOBLOCK KD LL PUN BLIS

CODIGO	VALOR
1400401017	



CANDADO ACERO ARCO 96 TI/60

CODIGO	VALOR
1400104016	



CADENA ACERO ABUS

CODIGO	MEDIDA	VALOR
1400105002	8MM X 140CM	

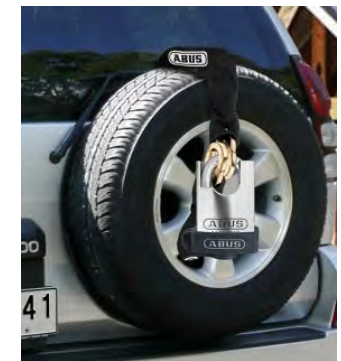

OFERTA

CADENA ESLABON LARGO

MEDIDA 4,7MM X 58



COD.1150201001



CADENA ESLABON CORTO

CODIGO	MEDIDA	VALOR
1150103003	8 MM X 30	
1150103001	5 MM X 61	
1150103002	6 MM X 61	



CADENA ESLABON LARGO

CODIGO	MEDIDA	VALOR
1150103006	8 MM X 30	
1150103004	5 MM X 61	
1150103005	6 MM X 61	

DEFENSA MURO



DEFENSA MURO TIPO ESCORPION SIMPLE CAJA 15 UND

CODIGO	MEDIDA	VALOR
1400301001	1.0 MT	



DEFENSA MURO TIPO ESCORPION DOBLE CAJA 6 UND

CODIGO	MEDIDA	VALOR
1400301002	1.0 MT	

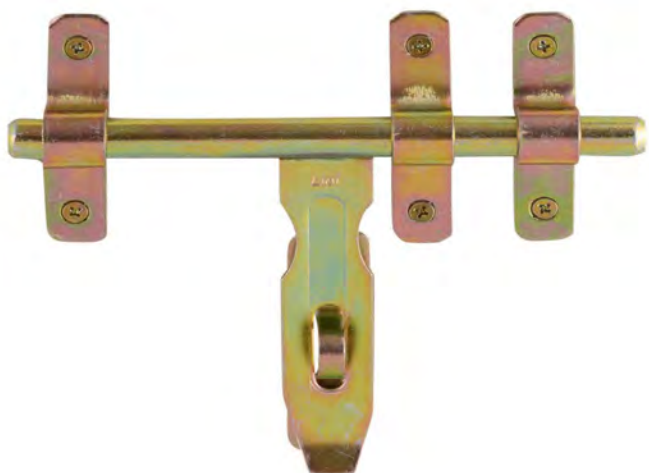

**CERROJO CARCELERO CON TORNILLO
CJ.10 UND**

CODIGO	MEDIDA	VALOR
1150102001	8"	
1150102002	10"	
1150102003	12"	

X UNIDAD



CERROJO HERCULES CJ. 10 UND.

CODIGO	MEDIDA	VALOR
1150102004	8"	

X UNIDAD

CONTROL DE PLAGAS

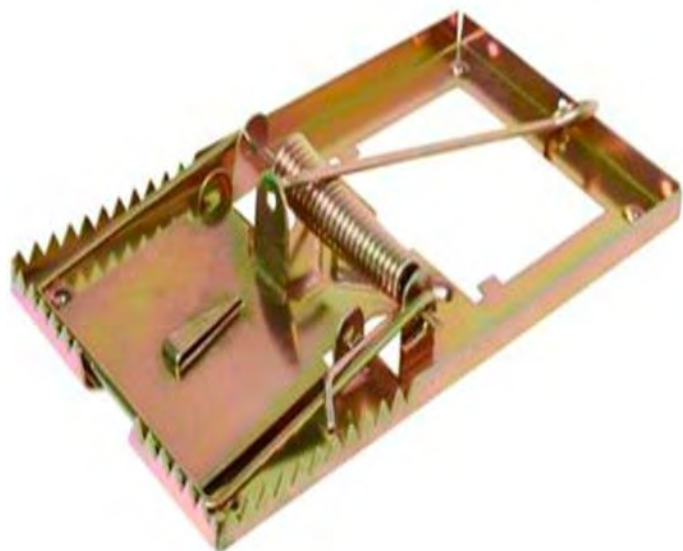

TRAMPA RATON ZINCADO

CODIGO	VALOR
1150101001	

X UNIDAD

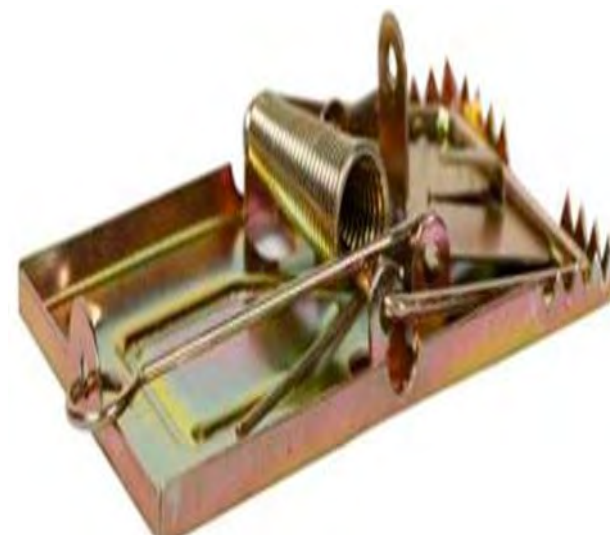

TRAMPA LAUCHA ZINCADO

CODIGO	VALOR
1150101002	

X UNIDAD



**BURLETE PVC FLEXIBLE
PUERTA CAFÉ**

CODIGO	MEDIDA	VALOR
1200601002	38MM X 100	



**BURLETE TIPO P 6 M
PUERTAS Y VENTANAS**

CODIGO	VALOR
1200601001	



**BURLETE CEPILLO
PUERTA - CAFÉ**

CODIGO	MEDIDA	VALOR
1200601003	38MM X 100	



**BURLETE TUBULAR
DOBLE GEKO**

CODIGO	VALOR
1200601004	

Origen Italia



ELECTRODOS



CODIGO	MEDIDA	VALOR
3000305001	E6011 3/32	
3000305002	E6011 1/8	

CAJA DE 20 KILOS

ELECTRODOS



**DESCUENTOS
ADICIONALES
DESDE 2 CJ 5%
3 CJ A 5 CJ. UN 10%
SOBRE 5 CJ. UN 15%.**

CODIGO	MEDIDA
3000301006	6011 1/8
3000301005	6011 3/32
3000301003	7018 1/8
3000301004	7018 3/32

➤ SOLDADORA KRAFTER INVERTER DW120 BLACK

Soldadora compacta con tecnología IGBT que le entrega una mayor calidad de soldadura. Posee encendido de arco por contacto (Hot Star). Excelente proceso de soldadura, arco estable y baja salpicadura.

Cada elemento de la soldadora KRAFTER es diseñado para satisfacer las necesidades de los soldadores. Inverter DW120 BLACK puede ser utilizada con cables de alimentación extra largos (máx.10 m).

\$ 62.900 PRECIO MERCADO

COD: 2400105002
IMÁGENES



REGULADOR DE POTENCIA



CONECTORES RÁPIDOS



KIT DE ACCESORIOS



FÁCIL TRANSPORTE

SOLDADORA INVERTER KRAFTER DW160 BLACK

Soldadora compacta con tecnología IGBT que le entrega una mayor calidad de soldadura. Posee encendido de arco por contacto (Hot Star). Excelente proceso de soldadura, arco estable y baja salpicadura.

Cada elemento de la soldadora KRAFTER es diseñado para satisfacer las necesidades de los soldadores. Inverter DW160 BLACK puede ser utilizada con cables de alimentación extra largos (máx. 10 m).



COD: 2400105003

CARACTERÍSTICAS

- Cerrajería en general; cobertizos, marcos de ventana, mueblería metálica, etc
- Diseñado para uso liviano, simple y fácil de regular



REGULADOR DE POTENCIA /
PANEL DIGITAL



CONECTORES RÁPIDOS



FÁCIL TRANSPORTE

MASCARAS



MASCARA FOTOSENSIBLE

OFERTA DESDE 6 UNIDADES

\$ 12.200 C/U

CODIGO	VALOR
2800101001	



MASCARA ECONÓMICA CAJA 12 UND

CODIGO	VALOR
2800101003	



VIDRIO PARA/ MASCARA SOLDAR CAJA 12 UND

CODIGO	MEDIDA	VALOR
2800103001	108X50MM - N°10	
2800103002	108X50MM - N°12	

MASCARA FOTOSENSIBLE COLOR



**DISEÑO SEGÚN
DISPONIBILIDAD**

COD: 2800101002



ELECTRODO UYUSTOOLS CAJAS DE 20 KL

CODIGO	MEDIDA	VALOR
3000303003	7018 3/32	
3000303004	7018 1/8	



PORTA ELECTRODO 500 AMP

CODIGO	VALOR
2400301002	

SOLDADURA MIG 1.2 ROLLO 15K ALPHA PRO

COD. 3000401002

SOLDADURA MIG 0.8 ROLLO 15K ALPHA PRO

COD. 3000401001



SOLO A PEDIDO



**LAPIZ CARPINTERO UYUSTOOLS
CAJA 12 UND**

CODIGO	VALOR
2000104003	



**LAPIZ BICOLOR UYUSTOOLS
CAJA 12 UND**

CODIGO	VALOR
2000104004	



**LAPIZ NEGRO STANLEY
CAJA 30 UND**

CODIGO	VALOR
2000104006	

HUINCHAS



HUINCHA MEDIR KNIGHT

CODIGO	MEDIDA	VALOR
2000401007	5 MT	
2000401008	7,5 MT	
2000401009	10 MT	



HUINCHA MEDIR STANLEY

PROFESIONAL POWER LOCK

CODIGO	MEDIDA	VALOR
2000401006	5 MT	
2000401004	8 MT	
2000401005	10 MT	



HUINCHA MEDIR UYUSTOOLS

CODIGO	MEDIDA	VALOR
2000401010	10 MT	



HUINCHA MEDIR STANLEY PRO

CODIGO	MEDIDA	VALOR
2000401001	3 MT	
2000401002	5 MT	



LIJAS



LIJA MADERA SOLO PACK 50 UND

CODIGO	MEDIDA	UND	PQTE
1950101018	36 GRS		
1950101019	40 GRS		
1950101020	60 GRS		
1950101021	80 GRS		
1950101022	100 GRS		
1950101023	120 GRS		
1950101024	150 GRS		
1950101025	180 GRS		

LIJA DE BANDA 3 PIEZAS POR DISPLAY

CODIGO	MEDIDA	UND	DISPLAY
1950103001	60 GRS 3X18		
1950103002	80 GRS 3X18		
1950103003	120 GRS 3X18		
1950103004	60 GRS 3X21		
1950103005	80 GRS 3X21		
1950103006	120 GRS 3X21		
1950103009	120 GRS 4X24		





LIJA METAL PACK 50 UND

CODIGO	MEDIDA	UND	VALOR
1950101027	40 GRS		
1950101029	60 GRS		
1950101030	80 GRS		
1950101031	100 GRS		
1950101032	120 GRS		
1950101033	150 GRS		
1950101036	240 GRS		

LIJA AL AGUA PACK 50 UND

CODIGO	MEDIDA	UND	PQTE
1950101001	LIJA AL AGUA PLG GR 60		
1950101004	LIJA AL AGUA PLG GR 120		
1950101005	LIJA AL AGUA PLG GR 180		
1950101006	LIJA AL AGUA PLG GR 150		
1950101008	LIJA AL AGUA PLG GR 240		
1950101009	LIJA AL AGUA PLG GR 280		
1950101010	LIJA AL AGUA PLG GR 320		
1950101011	LIJA AL AGUA PLG GR 360		
1950101012	LIJA AL AGUA PLG GR 400		
1950101017	LIJA AL AGUA PLG GR 1200		



DISCO TRASLAPADO KLINGSPORT 115.

CODIGO	MEDIDA	VALOR
1010501015	GR 60	
1010501016	GR 80	



PLATO SOPORTE GOMA PARA ESMERIL Y TALADRO

CODIGO	MEDIDA	VALOR
1950104001	4 1/2	



DISCO FLAP

MADERA/ METAL

CODIGO	MEDIDA	VALOR
1010701004	4 1/2 GR 60	
1010701003	4 1/2 GR 80	
1010701002	4 1/2 GR 100	
1010701005	4 1/2 GR 40	
1010701001	4 1/2 GR 120	



DISCO FIBRA PARA ESMERIL CAJA 25 UND

CODIGO	MEDIDA	UND	CAJA
1950102002	4 1/2 GR 40	490	
1950102003	4 1/2 GR 60	490	
1950102004	4 1/2 GR 80	490	
1950102005	4 1/2 GR 100	490	
1950102006	4 1/2 GR 120	490	
1950102001	4 1/2 GR 24	650	

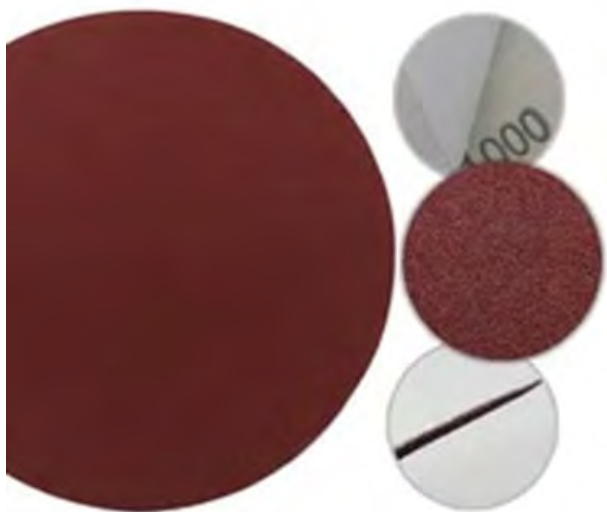

DISCO C/VELCRO 4 ½
DISPLAY 5 UND

CODIGO	MEDIDA	UND	DISPLAY
1950102007	40		
1950102008	60		
1950102009	80		
1950102010	120		
1950102011	180		



PLATO SOPORTE GOMA PARA
ESMERIL LIJA CON VELCRO 4 1/2

CODIGO	MEDIDA	TOTAL
1950104002	4 1/2	



IMAGEN REFERENCIAL

ESCOBILLA ACERO MANGO MADERA 6 FILAS



CAJA DE 12 UND

VALOR UNIDAD

COD: 2000106001

DISCO CORTE



DISCO CORTE STANLEY 1mm

CAJA 100 UND (SET DE 10)

CODIGO	MEDIDA	VALOR
1010101001	4 1/2 X 1MM	



DISCO CORTE NEXXO

CAJA 50 UND

CODIGO	MEDIDA	VALOR
1010101009	D4"½- 1mm	

150 UNIDADES

CAJA 10 UND

CODIGO	MEDIDA	VALOR
1010101012	D7"-1.6mm	

50 UNIDADES

DISCO CORTE



DISCO DIAMANTADO

CAJA 10 UNIDADES

CODIGO	MEDIDA	VALOR
1010202004	4 1/2 SEGMENTADO	
1010202003	4 1/2 CONTINUO	



DISCO CORTE 14" BAHCO TRONZADORA

CAJA 35 UNIDADES

CODIGO	MEDIDA	VALOR
1010101007	14" X 2,8MM	



DISCO CORTE MADERA 7 ¼ NEXXO



CODIGO	DIENTES	PRECIO
1010601007	24	
1010601008	40	
1010601009	60	



**ATORNILLADOR INHALAMBRICO TC-SD 3,6 LI**

CODIGO	VALOR
1901001007	



- Batería recargable de iones de litio
- La junta pivotante también permite su uso como destornillador
- Instalación inversa
- Luz LED
- Agarre suave
- Indicador LED de batería de 3 pasos
- Indicador luminoso de carga
- Incluye 6 bits
- 3,6 VOLT
- 1,3 Ah
- 200 rpm

CEPILLO ELECTRICO TC-PL 750

CODIGO	VALOR
1901001004	

- Cepillo manual para aplicaciones de hasta 2 mm de profundidad de pasada
- Eje de cuchillas de grandes dimensiones para unos óptimos resultados de cepillado
- Fijación segura de la cepilladora gracias a la zapata de sujeción automática
- Placas base de aluminio robusto para unos resultados de trabajo lisos
- Empuñadura ergonómica que permite trabajar sin fatiga
- Manejo seguro y cómodo gracias a la empuñadura Softgriff
- 750 W

LIJADORA ORBITAL TC-OS 1520



CODIGO	VALOR
1901001008	

- Lijadora orbital ligera y de fácil manejo
- Perfectamente apropiada para el lijado de superficies planas
- Cambio de papel abrasivo sencillo y rápido mediante cierre de gancho y bucle
- También apropiado para papeles abrasivos sin cierre de gancho y bucle
- Grandes superficies de agarre ergonómicas
- Apropiada para la conexión en una aspiración de polvo
- 130 W

SIERRA CIRCULAR TC-CS 1400



CODIGO	VALOR
1901001003	

- Sierra circular potente y de fácil manejo para cortes rectos en materiales derivados de la madera
- Parada segura gracias a la empuñadora grande
- También con un separador para mayor seguridad en el trabajo el separador se adapta automáticamente a la profundidad de corte
- Hoja de sierra de metal duro para cortes de forma transversal y longitudinal respecto a la fibra
- Regulación de profundidad de corte sin herramientas para mejores resultados de corte
- Regulación de mesa de sierra sin herramientas para cortes oblicuos
- 1400 W



TALADRO INHALAMBRICO TE-CD 12/1 X-LI

CODIGO	VALOR
1901001006	

- Siempre lista para usar gracias a la tecnología Li-Ion sin autodescarga
- Máxima flexibilidad cuando se trabaja con el portabrocas extraíble
- Caja de cambios de 2 velocidades para perforación y atornillado
- Componentes electrónicos de velocidad para trabajos adaptados a los materiales y las aplicaciones
- 12 VOL
- 400 rpm
- 30 Nm



TALADRO PERCUTOR TE-ID 650 E

CODIGO	VALOR
1901001005	

- Mandril de cambio rápido
- Preselección de velocidad electrónica
- 2 funciones: perforación y perforación por percusión
- Con función de reversa para perforar y atornillar.
- Parada de profundidad en metales
- Con práctico gancho para cinturón
- 550 W
- Incluye maleta



TALADRO EINHELL TE-ID550

CODIGO	VALOR
1900101007	

- 550 Watt de Potencia
- MANDRIL DE 1/2", de 1.5mm a 13mm
- Metal / 25mm en Madera
- Velocidad Variable
- Reversa
- Percutor
- Mango con Tope de profundidad
- Incluye maleta

ESMERIL ANGULAR TC-AG 115/750



CODIGO	VALOR
1901001001	

- Protector de disco para mayor seguridad del usuario
- Sistema de bloqueo del husillo para cambiar las herramientas de forma fácil y cómoda
- Cabezal de engranaje metálico para un funcionamiento flexible
- Protección de reinicio para un trabajo seguro
- El asa adicional puede colocarse en 2 posiciones
- 750 W

SIERRA CALADORA TC-JS 60/1



CODIGO	VALOR
1901001002	

- Pequeño, ligero y móvil: para hacer trabajos ligeros de corte.
- Cambio de hoja de sierra fácil y sin herramientas.
- Control electrónico de velocidad para la velocidad ideal para material de trabajo.
- Baja vibración gracias al diseño bien equilibrado.
- La suela se puede girar para permitir cortes de hasta 45 °
- 410 W



ESMERIL ANGULAR

- Potencia: 650W
- Velocidad sin carga: 13000/min (rpm)
- Eje: 5/8"- 11/M14
- Diámetro de disco: 4-1/2" (115 mm)
- Longitud del cable: 2 metros
- Interruptor de sellado contra polvo con bloqueo para uso continuo

INCLUYE

- Esmeril Angular 650W BLACK+DECKER G650GL-B2C
- 1 Empuñadura lateral de 2 posiciones
- Llave
- GUANTES DE CUERO



**SET PUNTAS PHILLIPS N° 2**

COD. 1010301001

**SIERRA CIRCULAR STANLEY
7 1/4****1600 WATT + 2 DISCOS****MODELO SC16**

CODIGO	MEDIDA	VALOR
1900301002	1/4	

**INCLUYE MALETA DE REGALO +
25 DISCOS BLACK + DECKER
MEDIDA 4 ½**



KIT TALADRO MODELO SDH700K

- Potencia: 700Ws
- Velocidad sin carga:
0 - 2900/min
- Peso: 1.87 kg



COD: 1900101001



SIERRA CIRCULAR

Black & Decker

7 1/4 1400W

CAJA 2 UN.

CODIGO	VALOR
1900301001	



ESMERIL B&D 41/2

MOD. G-650

CODIGO	VALOR
1900202002	



SIERRA CALADORA KS501

Black & Decker 420W

1400W

CJ 2 un

CODIGO	VALOR
1900801001	



TALADRO PERCUTOR

TB555 3/8 550 W -VVR

CODIGO	VALOR
1900102001	



PACK BLACK+DECKER

SIERRA CIRCULAR + TALADRO 3/8 +

ESMERIL G720



CODIGO	VALOR
1900901003	



LIJADORA KS1 + SIERRA CALADORA

CODIGO	VALOR
1900901006	



KIT ACCESORIO P/COMPRESOR 5 PZ FLOWMAK

CODIGO	VALOR
1900901002	



PISTOLA PINTAR ELECTRICA FLOWMAK—220 VOLT

CODIGO	VALOR
1900901001	



MOTOSIERRA HUSQVARNA 120 ESPADA 16"

CODIGO	MEDIDA	VALOR
2400101002	16"	

MOTOSIERRA 435 ESPADA 18 MOTOR 40cc 2,1 HP

CODIGO	MEDIDA	VALOR
2400101003	18"	

MOTOSIERRA 445 ESPADA 18 MOTOR 45cc

CODIGO	MEDIDA	VALOR
2400101004	18"	

MOTOSIERRA 61cc ESPADA 20

CODIGO	MEDIDA	VALOR
2400101005	20"	

ACEITE CADENA MOTOSIERRA HUSQVARNA 1 LT.

CODIGO	MEDIDA	VALOR
2400202006	1 LTS	



ACEITE MOTORES DE 4 TIEMPOS

SAE 30

CODIGO	MEDIDA	VALOR
2400203010	600 CC	

PROCEDENCIA USA



ACEITE PARA CADENA MOTOSIERRA

CODIGO	MEDIDA	VALOR
2400203007	500 CC CAJA 18 UND	
2400203008	1 LT CAJA DE 12 UND	
2400203009	5 LT CAJA 4 UND	

A PEDIDO



ACEITE PARA MOTORES 2 TIEMPO

CODIGO	MEDIDA	VALOR
2400203001	50 CC CAJA 60 UND	
2400203002	125 CC CAJA 45 UND	
2400203003	250 CC CAJA 28 UND	
2400203004	500 CC CAJA 18 UND	
2400203005	1000 CC CAJA 12 UND	
2400203006	5.0 LT CAJA 4 UND	

SET 3 LIMAS REDONDAS PARA MOTOSIERRA

• DETALLES DEL PRODUCTO

- Lima de motosierras redonda para afilar el dentado de las cadenas de motosierra
- Las limas van presentadas en un embalaje especial, de tres en tres, con perforaciones para una fácil separación
- 12 paquetes de tres (36 limas) van embalados en una caja especial que sirve de Display.
- Lima de motosierras redonda para afilar el dentado de la hoja de las motosierras.



CODIGO	MEDIDA	VALOR
2000601008	3/16	
2000601010	7/32	

CADENA STIHL ESLABON

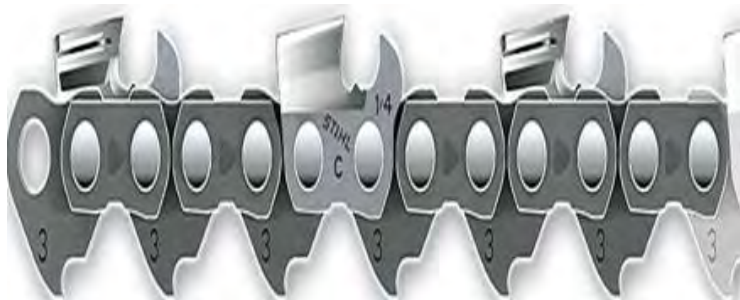

CADENA	MOTOSIERRA	VALOR
3/8 1.3P MICRO 50	MS 170 ESPADA 14"	
3/8 1.3P MICRO 55	MS 180 ESPADA 16"/ MS 210 ESPADA 16 "	
3/8 1.3P MICRO 61	MS 230 ESPADA 18"	
0.325 MICRO 68	MS 250 ESPADA 18"	
3/8 1.6 P MICRO 72	MS 310 ESPADA 20"	



**CADENA MOTOSIERRA SEMI
CHISEL**

SP 33G ESP. 18"

CADENA MOTOSIERRA H30 66
DL. ESP 16"



**CADENA PODADOR
DE ALTURA**

ESPADA 10" 58 DL.



CADENA MOTOSIERRA

H42 72 DL.
ESP 20"



SERRUCHO BAHCO BARRACUDA

\$ 6.490 X Caja 10 un.

CODIGO	MEDIDA	VALOR
2000601003	22"	



SERRUCHO BAHCO

PRICECUT 22" PROFESIONAL

CODIGO	MEDIDA	VALOR
2000601005	22"	



TRIPACK INCLUYE :
2 SERRUCHOS BAHCO 22"
+ 1 SERRUCHO BAHCO FINO
PARA MOLDURA DE 14"

CODIGO	VALOR
2000601014	



PRACTICO SET INCLUYE:
1 SERRUCHO 14" + 1 MINI SIERRA DE
6" DE REGALO

CODIGO	VALOR
2000601004	



SIERRAS SANDFLEX

CODIGO	VALOR
2000601001	



ARCO + SIERRAS SANDFLEX

CODIGO	VALOR
2000601002	



**JUEGO. DESTORNILLADOR 7PC
TRADICIONAL 4PLT+3 PHILL**

CODIGO	VALOR
2000601015	



MARTILLO CARPINTERO 20 oz

CODIGO	VALOR
2000601013	



**KIT LLAVES BICICLETA 17PC
C/FUNDA**

CODIGO	VALOR
2000601017	



LAPIZ CARPINTERO

NEGRO C/ U \$ 300

EXHIBIDOR 200 UND

CODIGO	VALOR
2000601007	



CAJA PORTA



CODIGO	VALOR
2000601018	



LAPIZ CARPINTERO BAHCO

CAJA 25 UND

CODIGO	VALOR
2000601006	



SET DE PRENSA RAPIDA BAHCO

2x 300-2x1500

CODIGO	VALOR
2000601016	

PALAS



PALA PUNTA HUEVO AZA MADERA Y MANGO PLASTICO

CODIGO	VALOR
2000701001	

DESDE 6 UNIDADES

PALA PUNTA HUEVO MANGO METALICO UYUSTOOLS

CODIGO	VALOR
2000701003	

DESDE 12 UNIDADES.





RUEDA C/EJE 350 X 8
5 PERNOS

CODIGO	VALOR
2000501001	



RUEDA SOLIDA
POLIURETANO 350 X 8

CODIGO	VALOR
2000501003	



NEUMATICO 350X8
UMC 6

CODIGO	VALOR
2000501004	



CAMARA
UMC 12

CODIGO	VALOR
2000501005	



**BOMBA ESPALDA
POWER PRO 15 LTS.**

CODIGO	MEDIDA	VALOR
2400701003	15 LTS	



**PALA PLASTICA NEGRA
CAJA 24 UND**

CODIGO	VALOR
1100201002	

**BARRE HOJAS METALICO
22 DIENTES CON MANGO DE
MADERA**



CODIGO	MEDIDA	VALOR
2000701002	22 DIENTES	



BALDE MULTI-USO

CODIGO	MEDIDA	VALOR
2000402001	12 LTS	



SECAPISO:

BARRE AGUA, USO
DOMESTICO E INTENSIVO

CODIGO	MEDIDA	VALOR
1100201006	45 CMS	

SE VENDE POR SEPARADO

MANGO DE ALUMINIO

CODIGO	MEDIDA	VALOR
1100201007	18 CMS	



MOPAS HUMEDAS FREGONAS

La Fregona en sus diferentes medidas dan un resultado satisfactorio en los lugares pequeños. Cumple de manera eficiente su labor, principalmente en los baños y salas reducidas. Con una rosca italiana para mango de escobillón tradicional soluciona el gran problema de la limpieza.



PRODUCTOS

Nº	Artículo	Color	Grs. Hilos	Corte hilo	Peso	Tipo
1	Fregona N°8 Hilo UBESOL	Blanca	125	58 cm	150 gr	Algodón



MOPA BOLSA FREGONA

CODIGO	MEDIDA	VALOR
1100201008	8	

NO INCLUYE MANGO

OFERTA



ESCOBILLON PLÁSTICO CON MANGO.

Caja de 36 UND.

X 12 und

X 1 caja

X 3 cajas y más

3 CAJAS = 108 UND

X 2 cajas

COD: 1100201005

SEÑALÉTICA PISO MOJADO LUSTER

De construcción plástica resistente para una estabilidad y resistencia al uso diario, este accesorio es fundamental para la seguridad en la limpieza, debe ser utilizado permanentemente en las distintas tareas diarias de mantención y limpieza de superficies.

- Altura adecuada para ser visible a distancia
- Asa para ser transportado en carros porta implementos
- Señal estampada infográfica de precaución
- Firmeza y rigidez cuando se apoya en pisos mojados y secos
- Texto en español, con tamaño de letras visibles a distancia
- Color amarillo seguridad visible a distancia

COD: 1100201009



ESPECIFICACIONES TÉCNICAS

Marca	LUSTER
Material	Poliuterano
Dimensiones producto	63 X 30 X 3,5 cm
Dimensiones empaque	31,5 X 28,5 X 65 cm
Peso	3,5 kg
Formato	Caja 10 ud.



VENTANA

CODIGO	MEDIDA	VALOR
3200101001	1,0 X 1,0	

ESCALA ARTICULADA

CODIGO	MEDIDA	VALOR
2000201004	3,55 MTS	



TUBO CORRUGADO ALUMINIO

El producto consiste en un cuerpo tubular con un diámetro de 5" o 4" que posee una superficie **corrugada**.

APLICACIONES

- CAMPANAS
- EXTRACCION DE AIRE
- VENTILACIÓN AIRE ACONDICIONADO

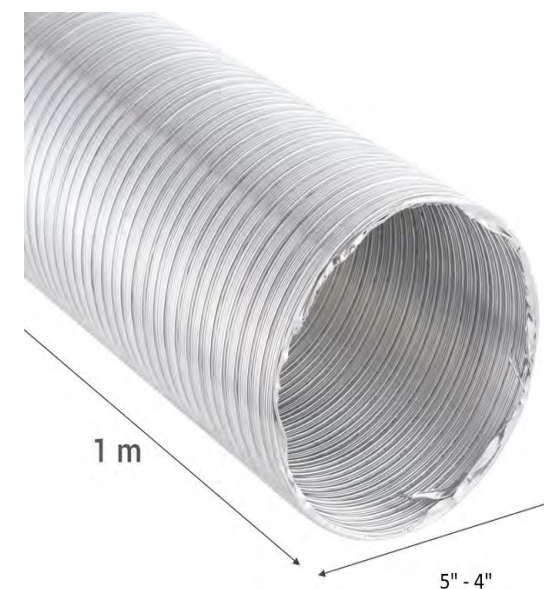

CODIGO	MEDIDA	VALOR
1801202002	4" D X 1 MT LARGO	
1801202003	5" D X 1 MT LARGO	

10 UND X CAJA

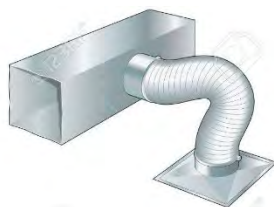
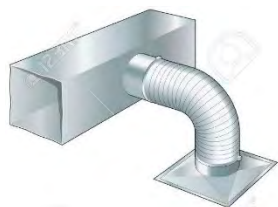



PRODUCTO	CÓDIGO	PRECIO
ELECTROBOMBA PERIFERICA 1/2 HP	2400801001	
ELECTROBOMBA CENTRIFUGA 1.0 HP	2400802001	
ELECTROBOMBA PEDROLLO PERIFERICA PKM-60	2400801003	

Producto a disponibilidad de proveedor



INTERRUPTOR NIVEL

CODIGO	MEDIDA	VALOR
2400803002	3 MTS	



CONTROLADOR ELECTRICO 1,5-2,2 CONNOR PARA BOMBA

CODIGO	VALOR
2400803001	



KIT HIDRONEUMATICO VAREM INCLUYE: MANOMETRO – CONTROL – VALVULA

CODIGO	MEDIDA	VALOR
2400803004	24 LTS	

POZO PROFUNDO



CODIGO	MEDIDA	VALOR
2400804005	20 MT	
2400804004	30 MT	
2400804015	40 MT	



BOMBA AUMENTO DE PRESION LRP15-90A/160 220V
PRESION DOMICILIARIA ENTRADA Y SALIDA ½ , ACTIVACION AUTOMATICA – 220 VOLT
COD. 2400801002



BOMBA SUMERGIBLE

0.40 HP 3.0- 13.5 M3/HR (PRF.MAX 4.5 MT)

COD. 2400804001

0.75 HP 3.0- 13.5 M3/HR (PRF.MAX 7.2 MT)

COD. 2400804002

10 MT CABLE + INTERR.NIVEL



BOMBA SUMERGIBLE

6.0 MT CABLE + INTERR.NIVEL

1.0 HP 3– 15 M3/HR (PRF.MAX 17 MT)

COD. 2400804003

PLETINA EN L C / PERNO



PRODUCT	CANTIDAD
66L	10

PLETINA EN T C / PERNO

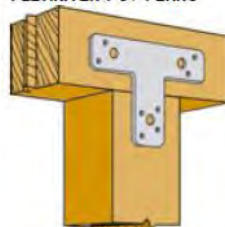

PRODUCT	CANTIDAD
66T	10

ESCUADRA DE ALTURA

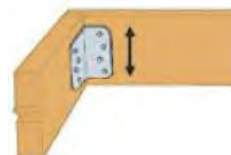

PRODUCT	CANTIDAD
ML24Z	15
ML26Z	15

SOPORTE DE VIGA M / CEPILLADA

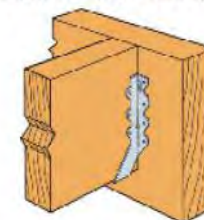

PRODUCT	CANTIDAD
LUS24Z	100
LUS26Z	100
LUS28Z	50

SISMO Y VIENTO DOBLE

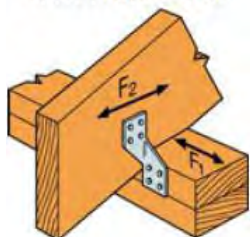

PRODUCT	CANTIDAD
H3	100

CLAVOS GALVANIZADOS



PRODUCT	CANTIDAD
N10DHDG	24
N8DHDG	24



TORNILLO GAVANIZADO INTERIOR



PRODUCT	CANTIDAD
SD8X1.25	24

ANGULO DE REFUERZO

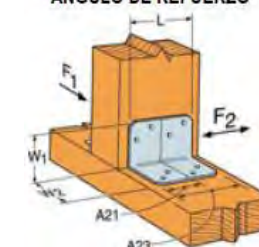

PRODUCT	CANTIDAD
A21	200
A23	200

ANGULO DE REFUERZO C / PERNO

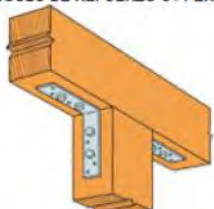

PRODUCT	CANTIDAD
A66	25

CONECTOR PARA CUMBRERA

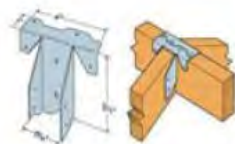

PRODUCT	CANTIDAD
RR	50

TORNILLOS SD ESTRUCTURALES



PRODUCT	CANTIDAD
SD9112R10	10

BASE DE POSTE C / ANCLAJE



PRODUCT	CANTIDAD
ITS2.56/9.5	25
ITS2.56/11.88	25

A PEDIDO

A PEDIDO

FLEJE ESPESOR 1MM

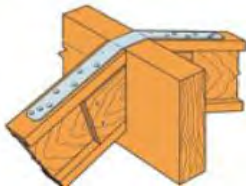

PRODUCT	CANTIDAD
LSTA12	50
LSTA9	50

ANGULO DE REFUERZO

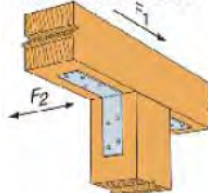

PRODUCT	CANTIDAD
A33	25
A44	25

FLEJE ESPESOR 1,3MM



PRODUCT	CANTIDAD
MSTA12	50
MSTA9	50

ANGULO DE REFUERZO SESGABLE

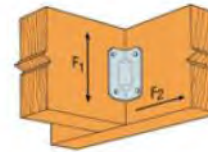

PRODUCT	CANTIDAD
GA1	100
GA2	100

ANGULO MULTIUSO

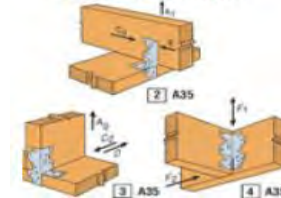

PRODUCT	CANTIDAD
A35	100

FLEJE DE CARGA PESADA



PRODUCT	CANTIDAD
HRS12	25
HRS6	25
HRS8	25

SISMO Y VIENTO LATERAL



PRODUCT	CANTIDAD
H2.5A	100

SOPORTE DE VIGA ALA INTERNA



PRODUCT	CANTIDAD
LUC26Z	100

SOPORTE DE VIGA M / BRUTA

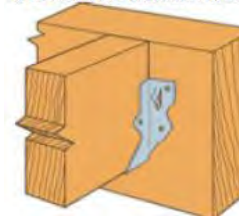

PRODUCT	CANTIDAD
LU24R-18	100
LU26R-18	100
LU28R-18	50

ESCUADRA PARA ESCALERA



PRODUCT	CANTIDAD
TA9Z	50

PLATOS CLAVABLES

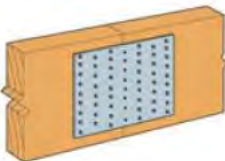

PRODUCT	CANTIDAD
TP15	150
TP35	100
TP37	100

AMARRA RIGIDA 90 GRADOS

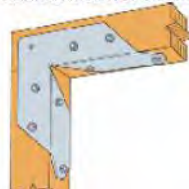

PRODUCT	CANTIDAD
RTA2Z	50



PRODUCT	CANTIDAD
MP14	100
MP24	100
MP36	100

BASE DE POSTE EMPOTRADA

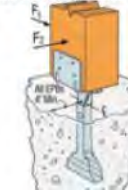

PRODUCT	CANTIDAD
EPB44A	10

SOPORTE DE VIGAS I - JOISTS 2TC

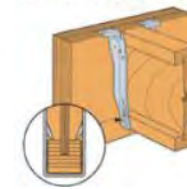

PRODUCT	CANTIDAD
ABA44RZ	10

LISTA PRECIOS			ene-20	
ITEM	CODIGO	DESCRIPCION	UN X CJ	P.V.D.
1	66L	PLETINA L 6 X6X10 UN	10	
2	66T	PLETINA T 6 X6X10 UN	10	
3	A21	ANGULO REFUERZO 38 X 35 200 UN	200	
4	A23	ANGULO REFUERZO 38 X 70 200 UN	200	
5	A24	PIE DERECHO 38 X90 MM CAL 12" 25 UN	25	
6	A33	ANGULO 3 X 3 1 1/2 25UN	25	
7	A35	ANGULO DE ENTRAMADO 1 7/16 X 4 1/2 100UN	100	
8	A44	ANGULO REFUERZO 49/16X 43/8 X 11/2 25 UN	25	
9	A66	ANGULO REFUERZO 5 7/8 X 1/2 25 UN	25	
10	ABA44RZ	BASE PARA POSTES 4 X 4"ZMAX 10 UN	10	
11	ABA66RZ	BASE PARA POSTES 6 X6 "ZMAX 10 UN	10	
12	EPB44A	BASE ELEVADA POSTE 4 10 UN	10	
13	FB24Z	SOPORTE DE CERCA 2 X 4" 100 UN	100	
14	GA1	ANGULOS DE REFUERZO Y SESGABLE 2 3/4 100 UN	100	
15	GA2	ANGULOS DE REFUERZO Y SESGABLE 3 1/4 100 UN	100	
16	H25A	AMARRA PARA SISMO Y VIENTO 5 7/16 X 1 9/16 100 UN	100	
17	H3	AMARRA PARA SISMO Y VIENTO 4 5/8 X 1 9/16 100 UN	100	
18	L70Z	ANGULO DE REFUERZO LARGO 7"ZMAX 50 UN	50	
19	HRS12	FLEJE 12"CARGA PESADA 25 UN	25	
20	HRS6	FLEJE 6"CARGA PESADA 25 UN	25	
21	HRS8	FLEJE 8"CARGA PESADA 25 UN	25	
22	LSTA12	FLEJE L=12 ESPESOR 1MM 50 UN	50	
23	LSTA9	FLEJE L=9 ESPESOR 1 MM 50 UN	50	
24	LUS24Z	ASIENTO VIGA 2X4"MADERAS CEPILLADA 100 UN	100	
25	LUS26Z	ASIENTO VIGA 2X6"MADERAS CEPILLADA 100 UN	100	

ITEM	CODIGO	DESCRIPCION	UN X CJ	P.V.D.
26	LUS28Z	ASIENTO VIGA 2X8" MADERAS CEPILLADA 50 UN	50	
27	LUC26Z	ASIENTO VIGA 2X6" MADERAS CEPILLADA ALETA INTERNA 25 UN	25	
28	LU24R-18	ASIENTO VIGA 2 X 4" BRUTO 100 UN	100	
29	LU26R-18	ASIENTO VIGA 2 X 6" BRUTO 100 UN	100	
30	LU28R-18	ASIENTO VIGA 2 X 8" BRUTO 50 UN	50	
31	ML24Z	ESCUADRA ALTURA 4 ZMAZ 15 UN	15	
32	ML26Z	ESCUADRA ALTURA 6 ZMAZ 15 UN	15	
33	MP14	PLACA DENTADA 1 X 4" 100 UN	100	
34	MP24	PLACA DENTADA 2 X 4" 100 UN	100	
35	MP36	PLACA DENTADA 3 X 6" 100 UN	100	
36	MSTA12	FLEJE L = 12 ESPESOR 1,3 MM 50 UN	50	
37	MSTA9	FLEJE L = 9 ESPESOR 1,3 MM 50 UN	50	
38	RTA2Z	CONECTORES RIGID TIE 2 X 2 50 UN	50	
39	N10DHDG-R	CLAVOS SIMPSON STRONG-TIE N10 0.148 X 3 24 UN	24	
40	N8DHDG-R	CLAVOS SIMPSON STRONG-TIE N8 0.131 X 2 1/2 24 UN	24	
41	SD8X1.25	TORNILLOS PARA MADERA 8 X 1 1/4 24 UN	24	
42	SD9112R100	TORNILLOS PARA CONECTORES ESTRUCTURALES 9 X 1 1/2 10 UN	10	
43	TA9Z	ESCUADRA PARA ESCALERAS 8 1/4 X 1 1/2" 20 UN	20	
44	TP15	PLATO CLAVABLE 1 X 5" 150 UN	150	
45	TP35	PLATO CLAVABLE 3 X 5" 150 UN	100	
46	TP37	PLATO CLAVABLE 3 X 7" 100 UN	100	
47	ABA44Z	BASE PARA POSTE AJUSTABLE 4X4 90 MM	20	

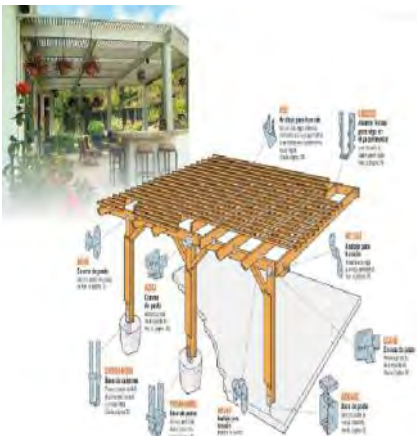



TORNILLO. VOLCANITA ZN
ROSCA GRUESA

CODIGO	MEDIDA	CJ MASTER	VALOR
3100101001	6 x 1	60 UND	
3100101002	6 x 1 1/4	60 UND	
3100101003	6 x 1 5/8	60 UND	
3100101004	6 x 2	20 UND	
3100101005	6 x 2 1/2	36 UND	
3100101006	8 x 3	36 UND	
3100101007	8 x 3 1/2	18 UND	
3100101014	8 x 4	20 UND	

CAJAS DE 100 UNIDADES



TORNILLO VOLCANITA ZN

CODIGO	MEDIDA	VALOR
3100101011	6 x 1 1/4	
3100101010	6 x 15/8	

AGOTADO

BOLSA ZIPLOC X 1.000 UND

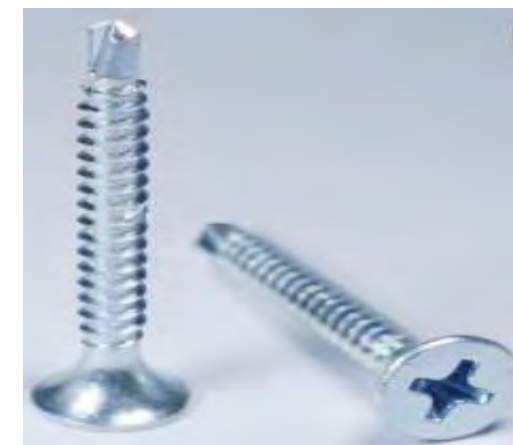

TORNILLO VOLCANITA
PUNTA BROCA ZINCADO

CODIGO	MEDIDA	CJ MASTER	VALOR
3100105003	6 X 1	100 UND	
3100105001	6 x 1 1/4	50 UND	
3100105002	6 x 1 5/8	50 UND	
3100105004	6 X 2	60 APROX	

CAJAS DE 100 UNIDADES



TORNILLO HEXAGONAL

PTA . BROCA— CON GOLILLA



CODIGO	MEDIDA	CJ MASTER	VALOR
3100301006	12x 1	20 UND	
3100301004	12 x 1 1/2	20 UND	
3100301001	12 x 2	20 UND	
3100301002	12 x 2 1/2	20 UND	
3100301003	12 x 3	15 UND	

CAJAS 100 UNIDADES

TORNILLO TECHO PUNTA

ESPADA (C/GOLILLA) PARA MADERA



CODIGO	MEDIDA	CJ MASTER	VALOR
3100401006	10 x 1	20 UND	
3100401003	10 x 1 1/2	20 UND	
3100401001	10 x 2	20 UND	
3100401002	10 x 2 1/2	20 UND	
3100401007	10 x 3	15 UND	

CAJAS 100 UNIDADES



TORNILLO CAB/LENTEJA PUNTA BROCA

CODIGO	MEDIDA	CJ MASTER	VALOR
3100202001	8 x 1/2	100 UND	
3100202002	8 x 3/4	50 UND	
3100202003	8 x 1	50 UND	

TORN.CAB/LENTEJA PUNTA FINA

CODIGO	MEDIDA	CJ MASTER	VALOR
3100201001	8 x 1/2	100 UND	
3100201002	8 x 3/4	50 UND	
3100201003	8 x 1	50 UND	155

MOLDURAS

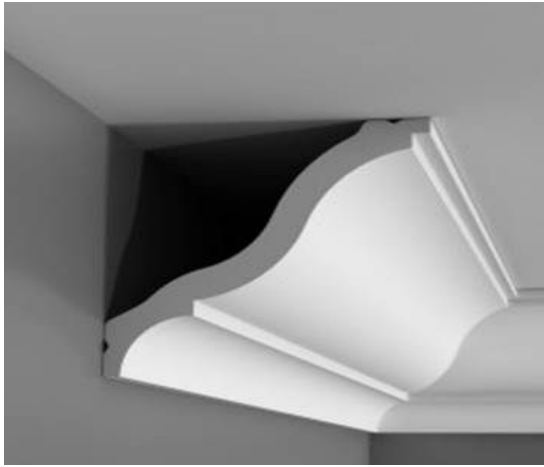

E6 - F

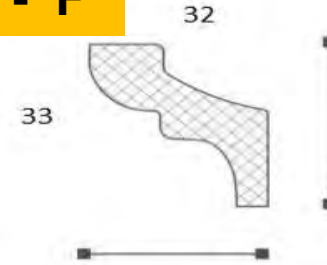

E14 - A2

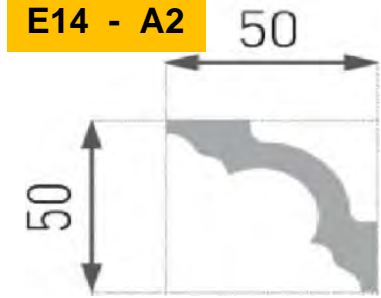

E7 - D

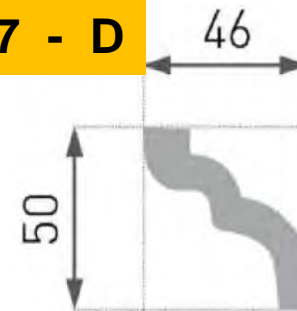

E40 - J

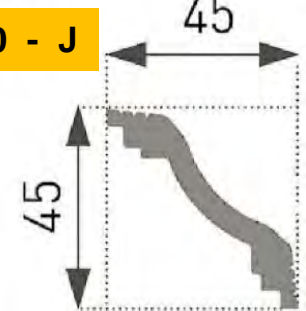

TIPO	UNI/CJ	MARBET★	NMC
E17 - LX28	170 - 140		
E2 - E	200 - 176		
E6 - F	110 - 115		
E24 - A3	140 - 115		
E11 - B2	130 - 95		
E7 - D	75 - 60		
E40 - J	85 - 48		
E5 - H	90 - 50		
E12 - B5	64 - 48		
E14 - A2	72 - 50		

E11 - B2

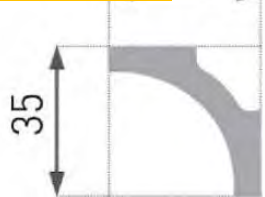

E5 - H

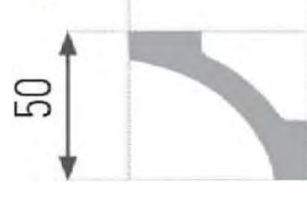

E24 - A3

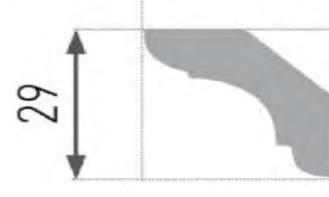

E12 - B5

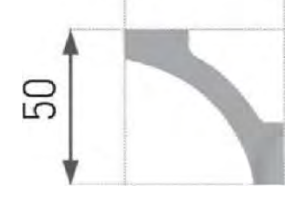

E2 - E

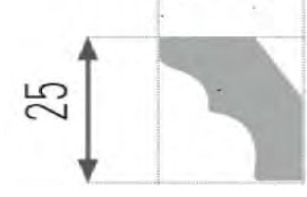

E17 - LX28

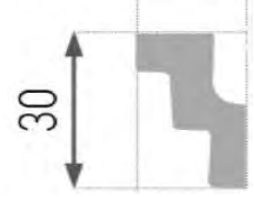



COLORES REFERENCIALES

BOLSA x 1 Kg

PROPIEDADES TX-FRAGÜE IMPERMEABLE

ESPEJOR JUNTA	BOLSA 1 KG	BOLSA 5 KG
2 MM	5 M ²	25 M ²
3 MM	3 M ²	15 M ²
5 MM	2 M ²	10 M ²

FORMATO	RENDIMIENTO
1 KG	0,78 LT/SACO
5 KG	3,902 LT/SACO

APLICACIONES

CERÁMICO - MÁRMOL - GRES
PIEDRA - PORCELANATO





SIKA LATEX

CODIGO	MEDIDA	VALOR
2900901009	950 ML CAJA 14 UND	



SIKA 3 ACELERA FRAGUE

CODIGO	MEDIDA	VALOR
2900901013	4,5 LTS CAJA 4 UND	



SIKA ACELERANTE DE FRAGUADO

CODIGO	MEDIDA	VALOR
2900901008	950 ML CAJA DE 14 UND	



SIKA 1

CODIGO	MEDIDA	VALOR
2900901007	950 CC CAJA 14 UND	
2900901012	4, 5 LTS CAJA 4 UND	



SIKADUR -31 HI

CODIGO	MEDIDA	VALOR
2900901010	1 KILO CAJA DE 6 UND	



SIKA IGOL DENSO

CODIGO	MEDIDA	VALOR
2900901014	3 LTS	

OFERTA

SILICONA SOUDAL TRANSPARENTE CON FUNGICIDA BAÑO/ COCINA



Caja con 12 unidades.



ESPUMA POLIURETANO

LÍNEA
PRO **SOUDAL**



Instalación de marcos de ventanas y puertas. Relleno de cavidades.

Sellado de todo tipo de aberturas en construcciones de techos. Aplique una pantalla acústica. Mejora del aislamiento térmico en sistemas de refrigeración

COD : 2900701004

SUPER OFERTA



SILICONA ALTA TEMPERATURA

X caja 12 un.

COD. 2900301003



TAPAGOTERA SOUDAL NEGRA

X caja 12 un.

COD. 2900601002

HASTA AGOTAR STOCK



**MONTAJE INTERIOR
SIN CLAVOS Y TORNILLO
BLANCO**
CJ 12 UN

CODIGO	VALOR
2900101001	



ALTA TEMPERATURA
CJ12 UNI

CODIGO	MEDIDA	VALOR
2900301001	300 ML	



**SILICONA BAÑO-COCINA
TRANSPARENTE CON
FUNGICIDA BLANCO**
CJ 12 UN

CODIGO	VALOR
2900401001	

PISTOLA CALAFATERA



CODIGO	VALOR
2000105001	



**SELLADOR ACRILICO PINTABLE
BLANCO**
CJ 12 UN

CODIGO	VALOR
2900201001	



ESPUMA POLIURETANO
CJ 12 UND

CODIGO	MEDIDA	VALOR
2900701001	500 GR	
2900701002	500 + 250 GR	



TAPAGOTERA (REX)
CJ 12 UND

CODIGO	VALOR
290120700	

AGOTADO



TAPAGOTERA GRIS SIKA
CAJA 12 UND

\$ 45.480 CAJA

CODIGO	MEDIDA	VALOR
2900901006	300 ML	



SIKAFLEC 11 FC

CODIGO	MEDIDA	VALOR
2900901001	300 ML	
2900901002	300 ML	

SELLADOR Y TAPAGOTERAS



Bostik P795
SELLADOR POLIURETANO
300 ML. GRIS BETON P795
 CJ 12 UND

Bostik A330
ACRILICO PINTABLE
CAJA 25 UND

Bostik MAMUT
Multiuso Hibrido
de alta adherencia
22kg/Cm²

CODIGO	MEDIDA	VALOR
2901101004	300 ML	

CODIGO	MEDIDA	VALOR
2901101009	310 ML	

CODIGO	MEDIDA	VALOR
2901101006	290 ML	

Bostik A330

CAJA 25 UND



CODIGO	MEDIDA	VALOR
2901101009	310 ML	

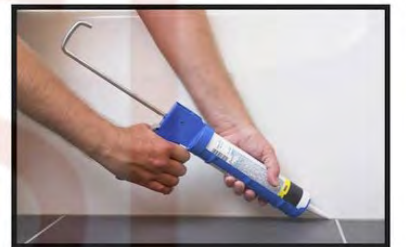

ACRILICO PINTABLE

EMBALAJE

MASKING TAPE (ENMASCAR)

CODIGO	MEDIDA	VALOR
1200101001	18 MM X 40 MT CAJA 48	
1200101002	24 MM X 40 MT CAJA 36	
1200101003	36 MM X 40 MT CAJA 24	
1200101004	48 MM X 40 MT CAJA 24	

OFERTA x 3 cajas 48 MM \$ 1.090



CINTA EMBALAJE FRAGIL

PACK 6 UND

CODIGO	MEDIDA	VALOR
1200201010	48 MM	



TRANSPARENTE
X CJ 144 UN.

CAFÉ
X CJ 144 UN.

100 YARDAS



FILM STRECH
(EMBALAJE)

1.0 kg ; 50 CM.

FILM STRECH
(EMBALAJE) 2.0



MALLA UNION VOLCANITA

CODIGO	MEDIDA	VALOR
1200401001	2 X 45 MT	



**CINTA ROJA/BLANCA
(REFLECTIVA)
(SEGÚN NORMATIVA VIGENTE)**



CODIGO	MEDIDA	VALOR
1200501001	50 MM X 45,72 MT	

CINTA DUCTO PVC

PACK 6 UN



CODIGO	MEDIDA	VALOR
1200201007	48 MM X 10 YD	



CINTA PELIGRO

CODIGO	MEDIDA	VALOR
2800701001	350 MT	

ALAMBRE NYA



CODIGO	PRODUCTO	MEDIDA	VALOR
1500303001	ALAMBRE NYA BLANCO	1,5 MM ROLLO 100 MTS.	
1500303002	ALAMBRE NYA ROJO	1,5 MM ROLLO 100 MTS.	
1500303003	ALAMBRE NYA VERDE	1,5 MM ROLLO 100 MTS.	
1500303007	ALAMBRE NYA BLANCO	2,5 MM ROLLO 100 MTS.	
1500303009	ALAMBRE NYA VERDE	2,5 MM ROLLO 100 MTS.	
1500303008	ALAMBRE NYA ROJO	2,5 MM ROLLO 100 MTS.	

CARRETE ALAMBRE NYA

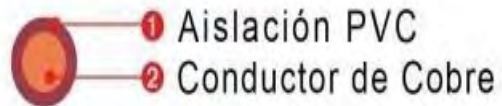

CODIGO	PRODUCTO	MEDIDA	VALOR
1500303004	ALAMBRE NYA BLANCO	1,5 MM CRR X 1000 MT	
1500303005	ALAMBRE NYA ROJO	1,5 MM CRR X 1000 MT	
1500303006	ALAMBRE NYA VERDE	1,5 MM CRR X 1000 MT	
1500303011	ALAMBRE NYA ROJO	2,5 MM CRR X 700 MT	
1500303010	ALAMBRE NYA BLANCO	2,5 MM CRR X 700 MT	
1500303012	ALAMBRE NYA VERDE	2,5 MM CRR X 700 MT	

CABLE EVA LIBRE DE HALOGENO



CODIGO	PRODUCTO	MEDIDA	VALOR
1500303013	CABLE EVA BLANCO	1,5 MM ROLLO 100 MTS.	
1500303014	CABLE EVA ROJO	1,5 MM ROLLO 100 MTS.	
1500303015	CABLE EVA VERDE	1,5 MM ROLLO 100 MTS.	
1500303021	CABLE EVA VERDE	2,5 MM ROLLO 100 MTS.	
1500303019	CABLE EVA BLANCO	2,5 MM ROLLO 100 MTS.	
1500303020	CABLE EVA ROJO	2,5 MM ROLLO 100 MTS.	

CABLE EVA LIBRE DE HALOGENO

NO TÓXICO



CODIGO	PRODUCTO	MEDIDA	VALOR
1500303016	CABLE EVA BLANCO	1,5 MM CRR 1000 MTS	
1500303017	CABLE EVA ROJO	1,5 MM CRR 1000 MTS	
1500303018	CABLE EVA VERDE	1,5 MM CRR 1000 MTS	
1500303023	CABLE EVA ROJO	2,5 MM CRR 1000 MTS	
1500303022	CABLE EVA BLANCO	2,5 MM CRR 1000 MTS	
1500303024	CABLE EVA VERDE	2,5 MM CRR 1000 MTS	

CORDONES Y CABLE ROLLO (100 MT)



CABLE PARALELO

CODIGO	MEDIDA	VALOR
1500302001	2 X 1,0 MT	
1500302002	2 X 1,0 MT	



NEGRO o BLANCO

CODIGO	MEDIDA	VALOR
1500301001	2 X 0.75 MM	
1500301006	2 X 1.0 MM	
1500301008	3 X 0.75 MM	
1500301012	2 X 1.5 MM	
1500301005	3 X 1.0 MM	
1500301003	3 X 1.5 MM	
1500301013	2 X 2.5 MM	
1500301011	3 X 2.5 MM	

AMARRA PLÁSTICA NEXXO

BOLSA 100 UN.

CODIGO	MEDIDA	VALOR
1500601013	150 X 2.5 MM NEGRO	
1500601014	200 X 4.8 MM NEGRO	
1500601045	300 X 4.8 MM BLANCO	





ALARGADOR

3 MTS X 6 ENTRADAS + INTERRUPTOR

CODIGO	MEDIDA	VALOR
1500601032	3 MT NEGRO	
1500601033	3 MT BLANCO	



PROBADOR CORRIENTE CAJA 12 UND

CODIGO	VALOR
2000104005	

ALARGADOR



CODIGO	MEDIDA	VALOR
1500601022	3 MT	
1500601034	1,5 MT	

ALARGADOR NARANJO SIMPLE



CODIGO	MEDIDA	VALOR
1500601050	10 MTS	
1500601052	20 MTS	

PROPIEDADES

- Construidos en referencia a las normas CEI 23-50 y CEI 23-124.
- Material auto extinguyente.
- Macho y hembra inyectados.

10 AMP 250 VOLT



REFLECTOR LED

CODIGO	POTENCIA	VALOR
1500604001	20 WATT	
1500604002	30 WATT	
1500604004	50 WATT	



REFLECTOR LED CON SENSOR VKB

CODIGO	POTENCIA	VALOR
1500604003	20 WATT	



CANOA CON TUBO LED

CODIGO	POTENCIA	VALOR
1500601001	10 WATT	
1500601002	20 WATT	

AMPOLLETA LED 9W

LUZ FRÍA



80 % AHORRO ENERGIA





CAJA DERIVACION

BOLSA 100 UND



CODIGO	VALOR
1500201004	NARANJA
1500201003	GRIS



CANALETA SIN ADHESIVO

BOLSA 50 UND

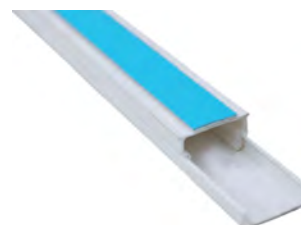

CODIGO	MEDIDA	VALOR
1500201001	20X10 SIN ADHESIVO	
1500201002	20X10 CON ADHESIVO	

177



CAJA CHUQUI PLASTICA

BOLSA 40 UND

CODIGO	VALOR
1500201005	

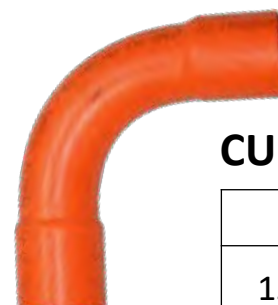

CURVA PV NARANJO CONDUIT

CODIGO	MEDIDA	VALOR
1500401001	16 MM	
1500401002	20 MM	

BOLSA 100 UND

CAJA ESTANCA



CODIGO	MEDIDA	VALOR
1500201011	85X85X50 CON SALIDA	
1500201012	85X85X50 SIN SALIDA	

SALIDA DE CAJA NARANJA 16 MM

BOLSA 200 UNIDADES



CODIGO	VALOR
1500402001	

LINEA AUTOMATICOS LEXO

CODIGO	TIPO	CAPACIDAD	U/C	VALOR
1500601049	CALOTA SOBREPUESTA 1 POLO BLANCO LEXO	1 POLO	1	
1500601008	INTERRUPTOR AUTOMATICO LEXO	10 Amp	12	
1500601009	INTERRUPTOR AUTOMATICO LEXO	16 Amp	12	
1500601010	INTERRUPTOR AUTOMATICO LEXO	20 Amp	12	
1500601011	INTERRUPTOR AUTOMATICO LEXO	25 Amp	12	
1500601030	INTERRUPTOR AUTOMATICO LEXO	6 Amp	12	
1500601031	INTERRUPTOR DIFERENCIAL LEXO	25 AMP	10	
1500601042	TABLERO SOBREPUESTO 6 POLOS	6 MODULOS	6	



INTERRUPTOR AUTOMÁTICO



IMAGEN REFERENCIAL

CODIGO	CAPACIDAD
1500601008	10 Amp
1500601009	16 Amp
1500601010	20 Amp
1500601011	25 Amp



IMAGEN REFERENCIAL

LINEA ENCHUFES VOLANTE

CODIGO	TIPO	COLOR	CAPACIDAD	U/C	VALOR
1500602001	ENCHUFE VOLANTE MACHO	NEGRO	10A 2PT	25	
1500602002	ENCHUFE VOLANTE MACHO	BLANCO	10A 2PT	25	
1500602004	ENCHUFE VOLANTE MACHO	NEGRO	10 AM 2P+ TIERRA	25	
1500602005	ENCHUFE VOLANTE MACHO	BLANCO	10 AM 2P+ TIERRA	25	
1500602003	ENCHUFE VOLANTE HEMBRA	BLANCO	10A 2PT	25	
1500601020	ADAPTADOR TRIPLE	NEGRO	10A 2PT	25	
1500601021	ADAPTADOR TRIPLE	BLANCO	10A 2PT	25	
1500601051	ADAPTADOR SCHUKO	BLANCO	10A 2P+T	1	



LINEA 9/12 SOBREPUESTO



CODIGO	TIPO	CAPACIDAD	U/C	Valor
1500601027	ENCHUFE SOBREPUESTO SIMPLE	10 Amp	10	
1500601029	INTERRUPTOR 9/12 SIMPLE+ENCHUFE	10 Amp	10	
1500601028	ENCHUFE SOBREPUESTO DOBLE	10 Amp	10	
1500601026	INTERRUPTOR SIMPLE 9/12 Blanco Lexo	10 Amp	10	
1500601041	TOMA CORRIENTE DOBLE	10/16 Amp	10	



LINEA 9/12 - ARMADO

CODIGO	TIPO	CAPACIDAD	U/C	Valor
1500202003	SOPORTE LEXO CON TORNILLOS	3 MODULOS	20	
1500601036	INTERRUPTOR SIMPLE 9/12	10A 250V	10	
1500601039	TOMA CORRIENTE DOBLE	10A 250V	10	
1500601029	INTERRUPTOR SIMPLE 9/12 + TM	10A 250V	10	
1500601037	INTERRUPTOR DOBLE 9/15	10A 250V	10	
1500601040	TOMA CORRIENTE TRIPLE	10A 250V	10	

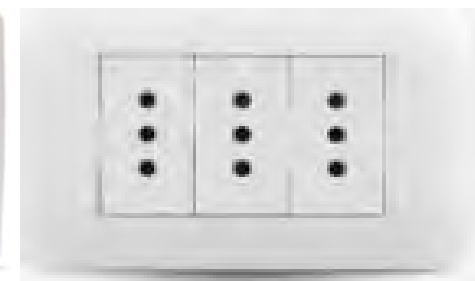
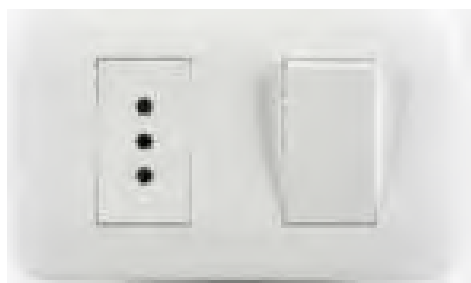

CINTAS AISLANTES LEXO

PACK 10 UND



CODIGO	MEDIDA	VALOR
1500601016	19 MM X 10 MT NEGRA	
1500601043	19 MM X 10 MT ROJA	



CINTA AISLANTES LEXO

PACK 10 UND

CODIGO	MEDIDA	VALOR
1500601017	19 MM X 20 MT NEGRA	
1500601044	19 MM X 20 MT ROJA	

TAPA CIEGA BLANCA

50 UND

CODIGO	MEDIDA	VALOR
1500202001	7,5 CMS X 11,5 CMS	



BARRA COOPER C/ABRAZADERA

Bolsa 20 und

CODIGO	MEDIDA	VALOR
1500501002	ABRAZADERA	
1500501001	1 MT	



**PORTALAMPARA
ESTANDAR**

Lexo E27 Blanco

Bolsa 25 und

CODIGO	VALOR
1500601023	



**MEDIDOR ELECTRICO MONOFÁSICO
220 VOLT.**

CODIGO	VALOR
1500603001	

EPPs

OVEROL POPLIN



CODIGO	MEDIDA	VALOR
2800401002	M	
2800401003	L	
2800401004	XL	
2800401005	XXL	



COLETO DESCARNE

CODIGO	MEDIDA	VALOR
2800402001	60 X 90	



BUZO DESECHABLE

CODIGO	MEDIDA	VALOR
2800401006	XL	
2800401007	XXL	
2800401009	XXXL	
2800401013	L	



LENTE PROTECTOR SPY-ART GRIS- TRANSPARENTE

12 UNIDADES X CAJA

CODIGO	VALOR
2800301001	
2800301002	



CAJA 50 Unidades
TALLA L NO APLICA EN OFERTA

GUANTES



GUANTE CABRITILLA

CODIGO	MEDIDA	VALOR
2800201001	10	



GUANTE ALBAÑIL

CODIGO	VALOR
2800202005	



GUANTE PVC ROJO 14"

CODIGO	MEDIDA	VALOR
280020213	14	



**GUANTE QUIMICOS VERDE
FLOCADO**

CODIGO	MEDIDA	VALOR
2800202006	10	



GUANTE SOLDADOR ROJO

CODIGO	MEDIDA	VALOR
2800201002	14	



GUANTES FLEX 66
Palma LATEX

CODIGO	MEDIDA	VALOR
2800202002	9	



GUANTES FLEX 55
Palma Nitrilo
CJ 120 / 12

CODIGO	MEDIDA	VALOR
2800202003	8	



GUANTES FLEX 70
GRIS SHOCK
ANTICORTE
PALMA LATEX

CODIGO	MEDIDA	VALOR
2800202014	9	



GUANTES PIGMENTADO
CJ 300 APROX.
Bolsa 12 pares

CODIGO	VALOR
2800203001	

PRODUCTO TEMPORADA



MARCA 7 MODELO	DIAMETRO	ESPESOR	LARGO	VALOR
NORWOOD	7,5mm	2,4mm	185mm	
SUNNYMET EP-5000 EP-5600	95mm	2,6mm	200mm	
SUNNYMET EP-7000 EP-7600	85mm	2,5mm	180mm	
ESTANDAR	9,5mm	2,3mm	175mm	
SUNNYMET EP 3000	95mm	2,3mm	190mm	
CORONA 23DK II	120mm	2,6mm	215mm	
TOYOTOMY RB 20 / ML 25	65mm	2,35mm	195mm	
TOYOTOMY OMNI 105 DC-100	105mm	2,5mm	195mm	
PASECO	120mm	3,3mm	200mm	
KS 27 / OMNI 85	85mm	2,4mm	195mm	
OMNI 230	120mm	3,1mm	200mm	
KS 23	65mm	2,35mm	195mm	
F 1120 PRO	85mm	2,8mm	195mm	
SENGOKU CV 2230	117mm	3,1mm	195mm	

